

# 2005 DOE Hydrogen, Fuel Cells and Infrastructure Technologies Program Review

## ***Fuel Cells Vehicle Systems Analysis (Fuel Cell Freeze Investigation)***

Ahmad Pesaran

Gi-Heon Kim, Tony Markel, and Keith Wipke

NREL

May 24, 2005

Project ID #

FCP19

This presentation does not contain any proprietary or confidential information

NREL/PO-540-38107

Presented at the 2005 Hydrogen Program Review, May 23-26, 2005, in Washington, D.C.

# Project Objectives and Targets

- Objectives

- Establish a fact-based strategy for rapid startup of PEM fuel cells from sub-freezing temperatures.
- Investigate the existing proposed solutions to rapid startup of PEM fuel cells.
- Use system analysis and other tools to aid in the evaluation and identification of strategies.
- Aid in developing fuel cells that startup at  $-20^{\circ}\text{C}$  in 30 seconds or less

<b>Key Targets</b>		
<b>Performance Measure</b>	<b>2010</b>	<b>2015</b>
<b>Rapid start up of PEM Fuel cell to 90% rated power from <math>-20^{\circ}\text{C}</math></b>	<b>30 S</b>	<b>&lt; 30 S</b>

To address Task 16 in the multiyear R&D Plan

# Project Overview

## Timeline

- Project start: FY04
- Project end: FY07
- ~20% complete

## Budget

- NREL FY04 funding (for Freeze): \$100K
- NREL FY05 funding: \$104K

## Fuel Cell Barriers

- A. **Durability** – Operation below freezing could damage the fuel cell.
- D. **Thermal, air and water management** – Addressing freeze is critical in water management of fuel cells.
- J. **Startup Time/Transient Operation**– Fuel cell power plant is required to start rapidly and flow the transient loads.

## Partners/Customers

- General Motors
- 3M
- Penn State

# Project Approach

- Collect data/information through literature search and collaborations.
- Conduct a detailed patent search and document the findings.
- Perform energy analysis to bracket energy/power requirements for startup.
- Use component/system models to evaluate merits of various solutions from fuel efficiency and other factors within a vehicle.
- Participate in the DOE fuel cell freeze workshop.

# Issues Found with Freeze & Rapid Startup of PEM Fuel Cells

A fuel “cell” can startup at sub-freezing temperatures, but product water may form ice if local sub-freezing still exist.

- Maintaining membrane integrity
- Fuel starvation (Elimination of water droplets from flow fields)
- Cathode ice formation
  - Product water forms ice on electrode and blocks air flow
  - Ice formation in cathode flow fields
- Rapid heat up of cell/cell manifolds to prevent ice formation
  - System heating issue:
    - Where is heat coming from and how much and how fast?
    - What is impact on energy consumption and overall efficiency?
  - Rapid heat up of humidifier to prevent membrane dry out
- Balance-of-plant: Heating of fluid/gas delivery systems
  - Prevent ice blockage
  - Thermal shock to mechanical components
  - Rapid startup and protection of components

Majority of these issues appears to be system related

# Accomplishments

## Results of Patent Search

- Search included US, Japan, and world patents
- Period of January 1988 to January 2005
- In the initial round, we used “Fuel Cell” and “Freeze” and/or “Thaw”
  - We found 1324 patents
  - Some related to reformer startup and other type of FC
- Further restricting the research to PEM and non-reformer and rapid startup
  - Reduced the number of patents to 177 (with some duplication in US, Japan, and world)
- Number of articles in “academic” literature less than 15, indicating that industry recognized early the importance of freeze and rapid startup.

# Results

## A Closer Look at the 1324 Patents

- Top categories
  - Fuel cell stack (212)
  - Piping (104)
  - Solid electrolyte fuel cell (119)
  - Polymer electrolyte (109)
  - Manifold (102)
  - Catalyst (71)
  - Cold-Starting (26)
  - Tank, Pure water (23)
  - Fuel cell power plant (24)
  - Antifreeze (10)
  - Other

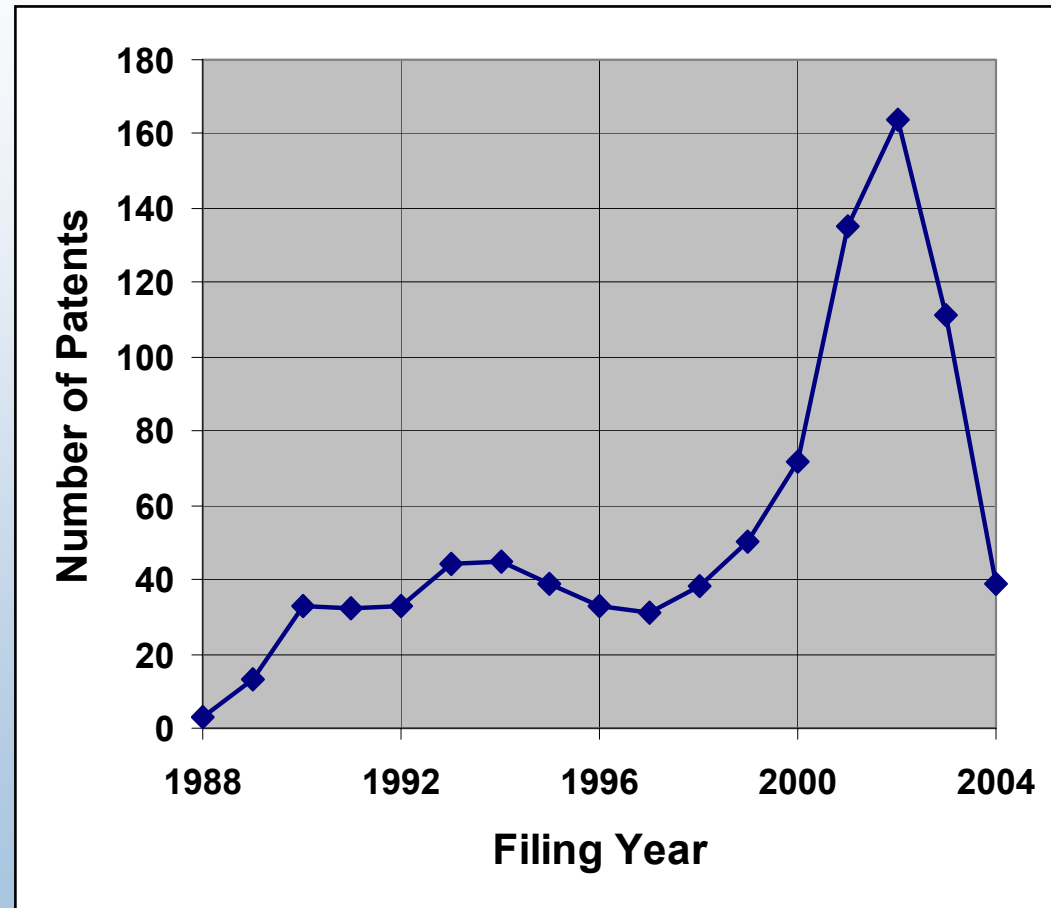

# Findings: Industry recognized early the importance of freeze issue.

Assignee	Doc Count	Percentage
NONE (Patent Applications for Individual Inventors)	174	 12.3%
FUJI ELECTRIC CO LTD	72	 5.1%
TOSHIBA CORP	59	 4.2%
HONDA MOTOR CO LTD	43	 3.0%
NISSAN MOTOR CO LTD	43	 3.0%
BALLARD POWER SYSTEMS INC.	36	 2.6%
SIEMENS AKTIENGESELLSCHAFT	35	 2.5%
SANYO ELECTRIC CO LTD	33	 2.3%
HONDA GIKEN KOGYO KABUSHIKI KAISHA	32	 2.3%
mitsubishi heavy ind ltd	32	 2.3%
TOYOTA MOTOR CORP	31	 2.2%
UTC FUEL CELLS, LLC	31	 2.2%
NISSAN MOTOR CO., LTD.	26	 1.8%
MATSUSHITA ELECTRIC INDUSTRIAL CO., LTD.	23	 1.6%
MITSUBISHI ELECTRIC CORP	20	 1.4%
<b>Number of assignments in Top 15 assignees</b>	<b>690</b>	
<b>Total number of assignments</b>	<b>1414</b>	
<b>Number of documents after filter</b>	<b>1324</b>	
<b>Total number of documents in group</b>	<b>1324</b>	



# Fuel Cell Patent Map With Freeze-Thaw Patents Highlighted in Red

Close up

Overall

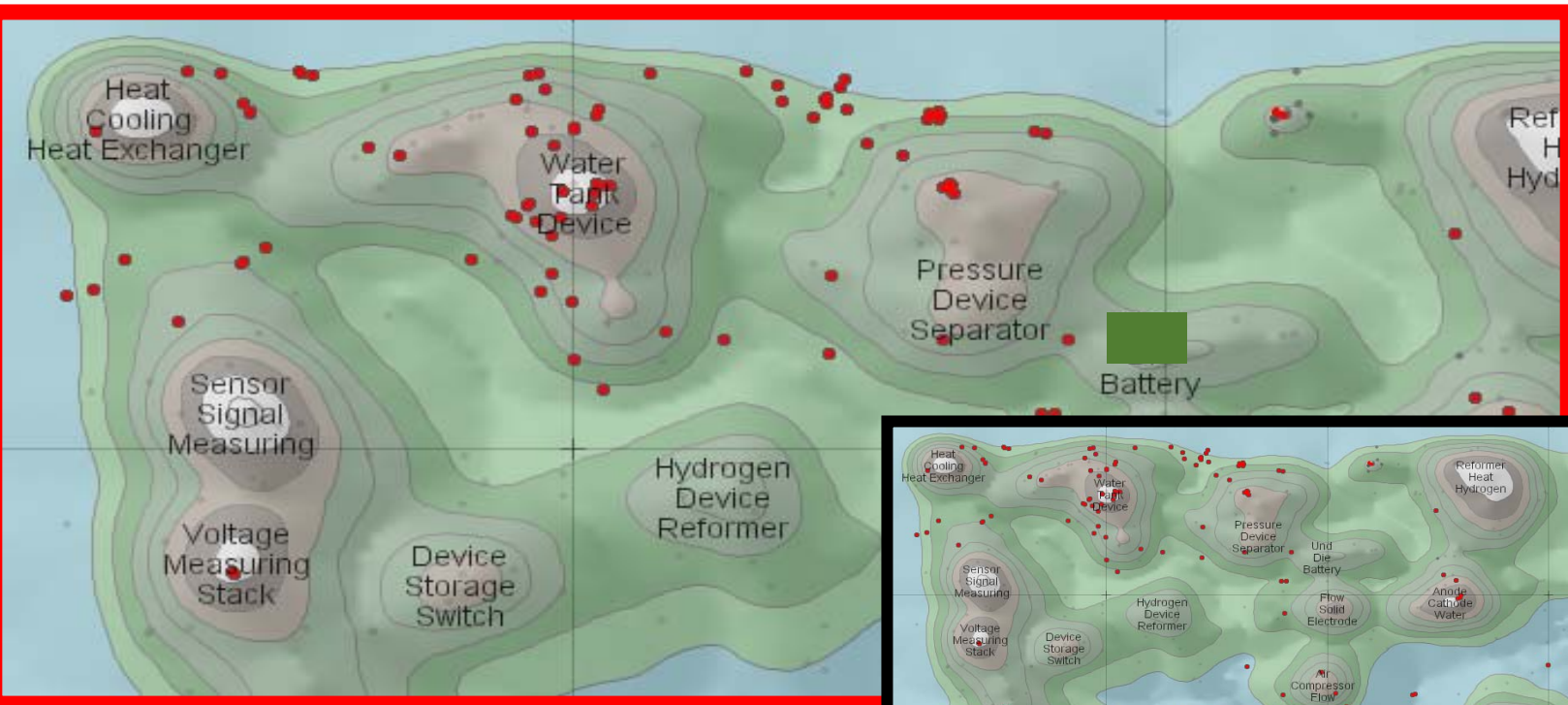

Major categories of the patents

- Materials: 10%
- Controls: 19%
- Components: 24%
- Subsystems: 47%

Systems Related Concepts: 90%

# Accomplishments: Prepared List of Relevant Patents in Tabular Format

Patent Number	Title	Assignee (patent owner)	Abstract	Patent Date
S006358638B1	Cold Start-up of a PEM Fuel Cell	General Motors Corporation, Detroit, MI (US)	A method of heating a cold MEA to accelerate cold start-up of a PEM fuel cell. The MEA is locally heated from below freezing to a suitable operating temperature by the exothermal chemical reaction between H <sub>2</sub> and O <sub>2</sub> on the anode and/or cathode catalysts. To their end, H <sub>2</sub> is introduced into the O <sub>2</sub> -rich cathode feed stream and/or O <sub>2</sub> is introduced into the H <sub>2</sub> -rich anode feed stream.	Mar 19, 2002
S006444345B2	Fuel Cell System	Xcellsis GmbH, Kirchheim/Teck-Nabern (DE)	A fuel cell system includes at least one fuel cell unit which is accommodated in a fuel cell enclosure. A cathode gas delivery line, cold-start gas delivery line, a cathode off-gas return line, anode off-gas return line may also be provided. According to the invention, the system is equipped with at least one Coanda flow amplifier in order to amplify the air stream for the purpose of ventilating the fuel cell enclosure, a cathode gas stream, a cold-start gas stream, a recirculated cathode off-gas stream or a recirculated anode off-gas stream. The may be equipped with a ventilating means for a housing outside the fuel cell enclosure. In the housing are components of the fuel cell system, said ventilating means including a Coanda flow amplifier.	Sept. 3, 2002
S006548200B2	Cold Starting of Gasoline Fueled Fuel Cell	UTC Fuel Cells, LLC, South Windsor, CT (US)	A fuel cell power plant has a fuel cell (38) receiving hydrogen (37) from a fuel processing system (12) which employs a vaporizer (19) to vaporize clean gasoline from a source (13). A conventional start burner (22) and startup heat exchanger (28) are utilized to convert water (31) from the fuel processing system (12) and fuel cell (38) into steam (32); but during sub-zero startup, an aqueous antifreeze solution (46) is provided to the heat exchanger (28) to produce the steam (32) for starting the vaporization of gasoline in the vaporizer (19).	Apr. 15, 2003

# Accomplishments: Patents Categorization

1. Water removal at FC shut down
2. Thermal insulation of FC and other components
3. Heating using waste heat from FC operation
4. Heating using hot air from compressor operation
5. Heating by burning hydrogen fuel
6. Keeping FC warm to prevent from freezing
7. Other methods

# 1. Removing the Water From FC at Shut Down

---

Water is removed from the fuel cell stack and freeze-sensitive components before it is shut down, so that water is not frozen in the stack and other component.

**Pros :**

- Minimizing the energy requirement for re-heating the FC system
- Preventing the system damage due to water freezing from occurring

**Cons :**

- Water must be added before the fuel cell can be operated

## **Related Examples :**

JP2004193102A2 (Honda Motor Co), JP2004111196A2 (Nissan Motor Co),  
US6358637 (General Motors Co), WO04017444A2 (General Motors Co), etc

**Methods :**

- Draining water with gravity
- Evaporating the water with a vacuum
- Discontinuing reactant humidification before shutting down

## 2. Thermal Insulation around FC and other Components

---

Insulation is used to keep the fuel cell stack and other freeze-sensitive components such as humidifier and water tank from freezing. Insulation is often integrated with the casing.

**Pros :** • Increase of cool down time after shut-down in sub-freezing environment

**Cons :** • Increase of stack volume and weight affecting vehicle performance, installed power requirements, and cost

### **Related Examples :**

US6756143 (Ballard Power System), JP2004241303A2 (Denso Corp), JP2004234892A2 (Nissan Motor Co), US6797421(UTC Fuel Cells, LLC), etc

**Comments :** • This approach occasionally used with Keep-Warm method  
• US5433056 and US5175975, assigned to NREL, present compact vacuum insulation which can provide the insulation volume reduction with on-and-off thermal insulation apparatus

# Analysis Approach

## 2. Thermal Insulation around FC and other Components

**Method Evaluation :** Estimating Energy & Power Requirement from Thermal Properties and Heat Transfer

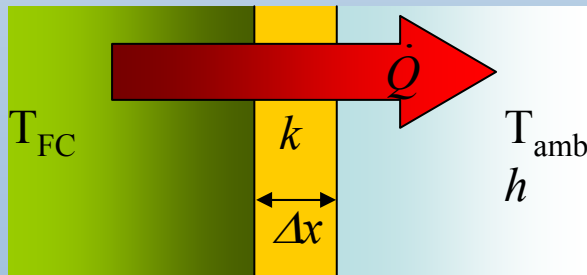
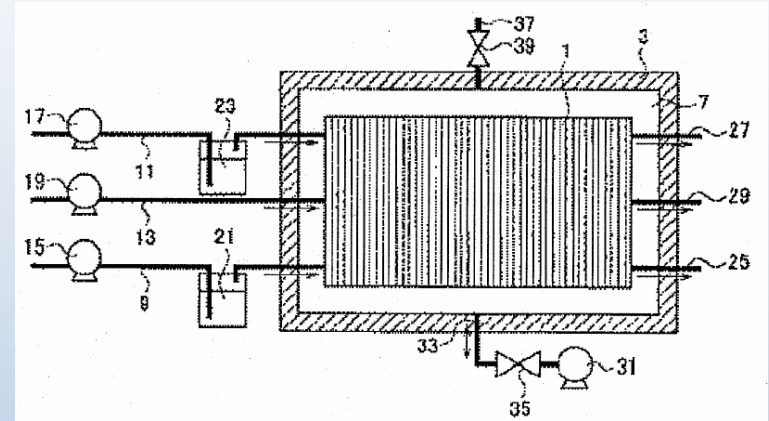
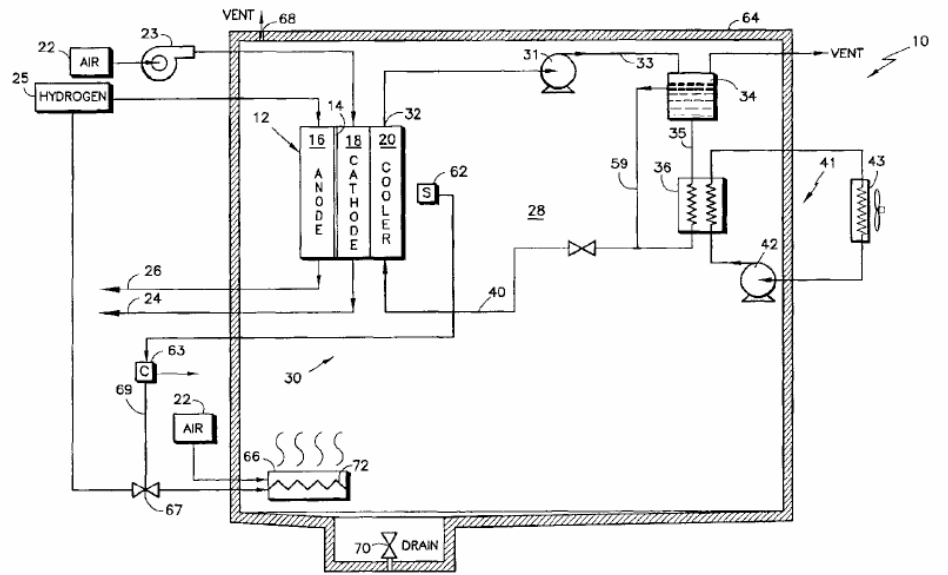

### Assumptions & Parameters

- Not Considering Radiative Heat Transfer
- Uniform Temperature inside FC
- Ambient Heat Transfer Coefficient: 10 W/m<sup>2</sup>·K
- Surface Area of Insulation Box: 1.4 m<sup>2</sup>
- Insulation Thermal Conductivity: 0.036 W/m·K
- System Temperature: 5°C

# Accomplishments: Estimated Energy and Power Needs

## 2. Thermal Insulation around FC and other Components

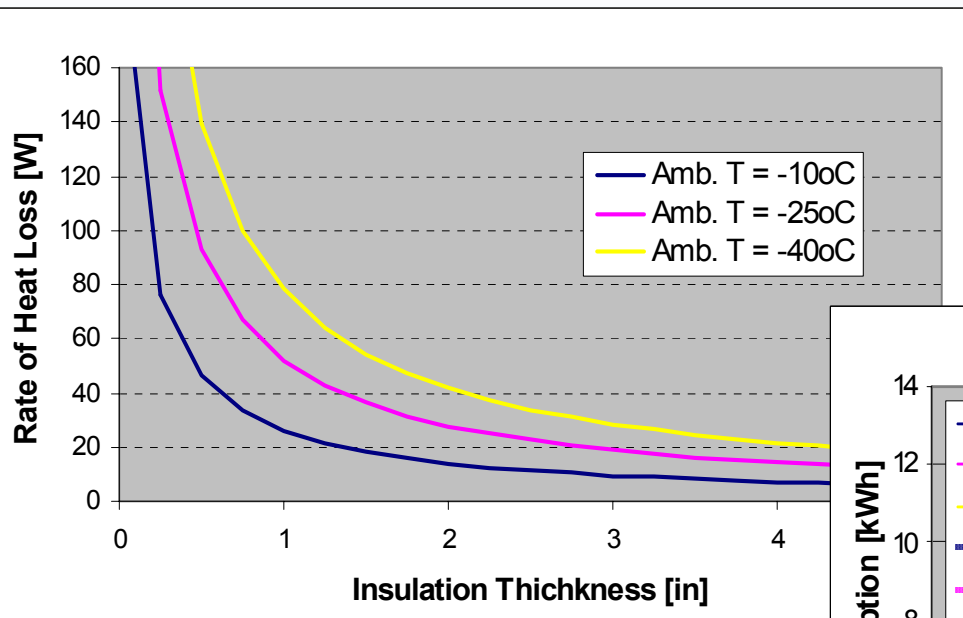

Energy consumption (left y axis) and Hydrogen consumption (kg right axis) for maintaining system temperature at 5°C

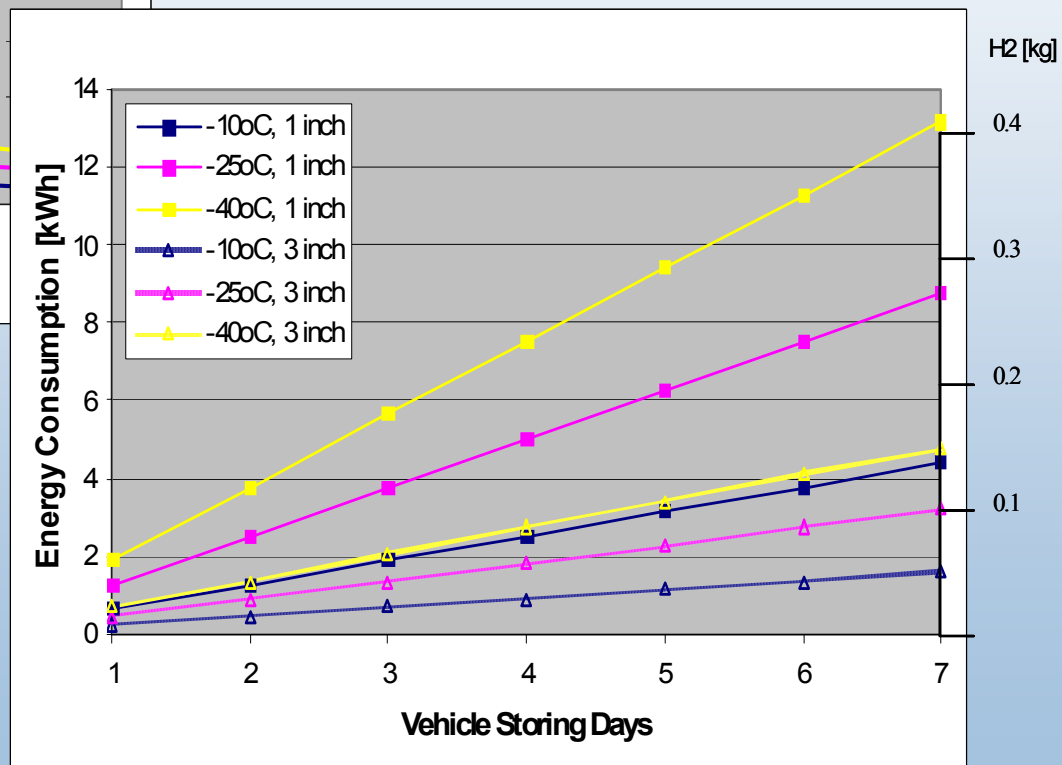

Power requirement for maintaining system temperature at 5°C

For thermal insulation methods, energy/fuel consumption could become large, reducing overall fuel economy of vehicle.

# 3. Heating Using Waste Heat from FC Operation

---

Supply fuel and oxidant directly to the fuel cell while drawing electrical power from the cell stack across a resistive load while the fuel cell stack is still in the frozen state.

**Pros :** • Relatively simple design that typically requires no system changes

**Cons :** • The product water accumulates within catalytic and diffusion layers and ices up at freezing temperatures blocking the porous structures  
• This approach takes several minutes to reach operational temperature

**Related Examples :**

US6777115, WO04025752 (UTC Fuel Cells, LLC), etc

**Comments :**

• According to the invention(US6777115), additional current provided by the battery initially forces the weak cells to a negative voltage which produces heat. thereby, the performance of the weak cells quickly, approaches typical performance of good cells.



## 4. Heating Using Hot Air from Compressor

---

Hot air is generated by the compression of air by the compressor. The heat is available relatively quickly and could be supplied to cathode side, which warms all portions of the MAE and starts melting any ice.

**Pros :**

- Hot air typically greater than 90°C is available relatively quickly
- Hot air warms all portions of the cathode and/or anode

**Cons :**

- Not much heating power is derived from air. However, the thermal mass of the membrane electrode assembly is very low.

### **Related Examples :**

US6815103 (Honda Giken Kogyo Kabushiki Kaisha), EP1113516B1 (General Motors Co), etc

### **Comments :**

- EP1113516B1 suggests that the dry fuel gas and oxidant gas are warmed and passed through the associated flow field for a sufficient time to de-ice the catalyst before introducing the O<sub>2</sub> and H<sub>2</sub> into the fuel or oxidant streams for catalytic heating.

# 5. Heating by Burning Hydrogen Fuel

---

Small amount of hydrogen is burned with air, either in a combustion chamber or catalytically to provide high quality heat to the manifold, MEA and other components.

- Pros :**
- Generation of a large amount of high-quality heat
  - Waste heat can be used to warm the passenger compartment

- Cons :**
- Decrease in fuel economy
  - Requirement for the hydrogen/air burners that add weight, volume and cost

**Related Examples :**

JP2004111243A2 (Nissan Motor Co), JP2004047210A2 (Nissan Motor Co), WO0148846A1 (PTC Int. App.), etc

**Comments :**

- US6797421B2 suggests that instead of using the reactants for heat by combustion, the system is heated by the exothermal catalytic reaction from a catalytic burner
- EP1113516B1 suggests that the MEA is locally heated from catalytic reaction between  $H_2$  and  $O_2$  on the anode and cathode catalysts

## 6. Keeping FC Warm to Prevent Freezing

---

FC system is kept warm by insulation, adding heat or combination of the two to keep the FC and other components from freezing while the vehicle is stored in subfreezing environment

**Pros :** • Addressing damages that may be caused when the fuel cell stack remains in a dwell or off-mode at low ambient temperatures

**Cons :** • Requiring complex, and therefore costly, energy demanding control schemes  
• Requiring great fuel consumption which limits the storage protection time available

**Related Examples :** US6727013B2(General Motors Co), EP1414090A1(Nissan Motor Co), US6797421B2(UTC Fuel Cells. LLC), etc

**Methods :** • US6727013B2 presents a heater to warm the fuel cell stack or the water supply, being connected to an output of the fuel cell stack  
• US6797421B2 suggests a catalytic burner obviating the need for parasitic electrical loads to produce heated gas  
• EP1414090A1 presents the controller determining a stop mode as a temperature maintenance mode or a defrost start-up mode

# Supporting Analysis

## 6. Keeping FC Warm to Prevent Freezing

**Method Evaluation :** Consideration of Power/Energy Requirement for Thawing

Energy Requirement for Heating-up  
FC from frozen state to 5°C

Assumptions & Parameters

- FC specific power ranging from 400 W/kg to 800 W/kg
- System Mass: 160kg
- Specific Heat of FC: 600 J/kg·K
- Water content ranging from 1.0 lit to 10 lit

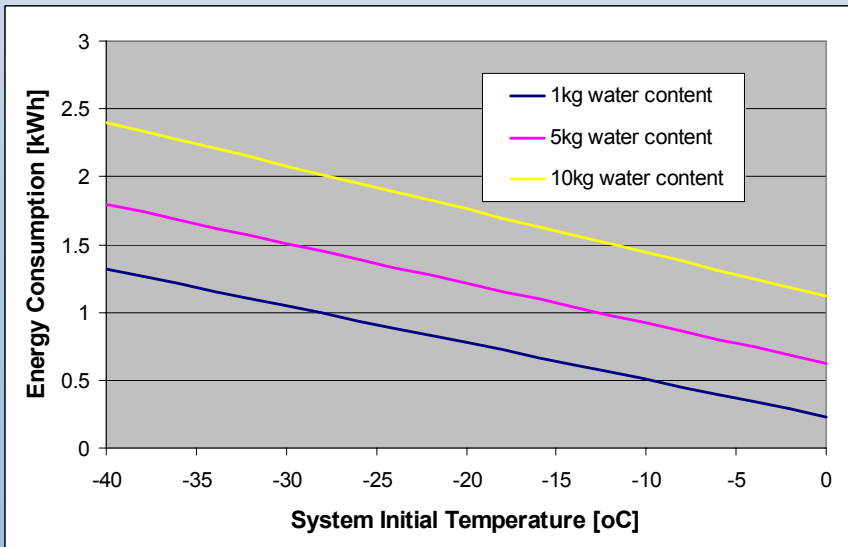

Comparison of Energy Consumption  
between Keep-Warm & Ice-Thawing

Assumptions & Parameters

- Ambient Heat Transfer Coefficient: 10 W/m<sup>2</sup>·K
- Surface Area of Insulation Box: 1.4 m<sup>2</sup>
- Insulation Thermal Conductivity: 0.036 W/m·K
- Insulation Thickness: 1 in
- System Temperature: 5°C

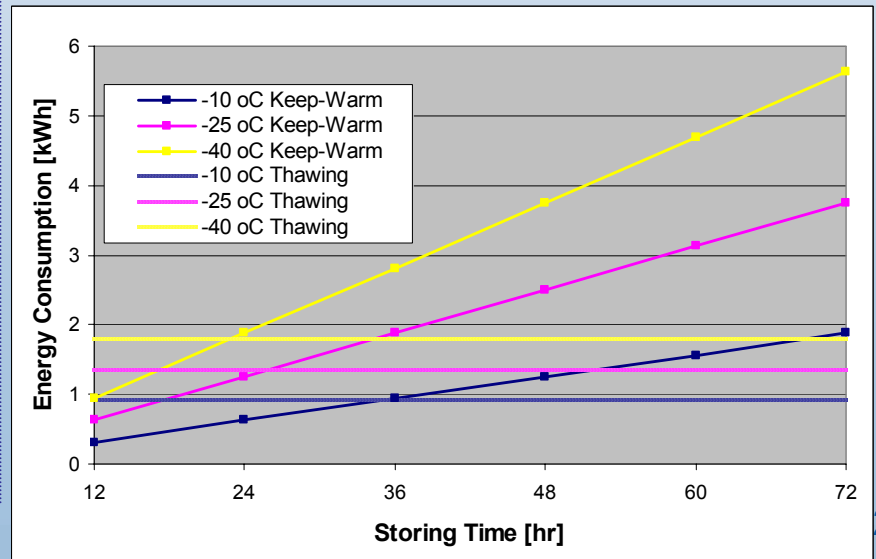

# Supporting Analysis

## 6. Keeping FC Warm to Prevent Freezing

Energy Need for Heating up a Frozen FC to 5°C from FC or another external source could be Reasonable, but Power Need could be not possible for short durations.

- Keep-Warm system does not require Thawing Power at system start

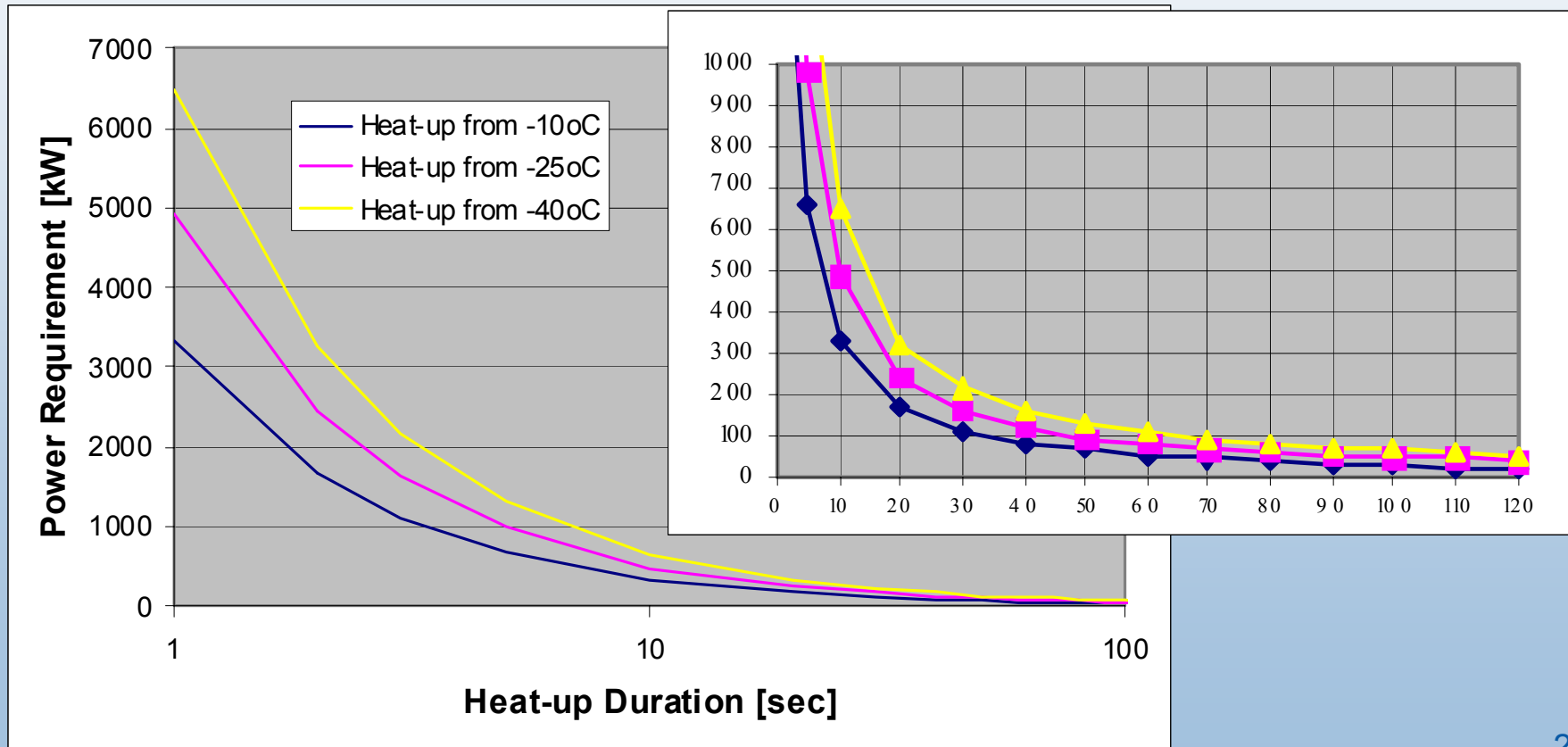

# 7. Other and Methods Approaches

---

- Minimizing freezing by minimizing the use of water coolant
  - Use of electrically non-conducting heat transfer anti-freeze liquid
  - EP1416563A1, US20040224201A1, WO04053015A1, US6562503
- Component Freeze Protection
  - Water tank, Humidifying system, Hydrogen pump, etc
  - Efficient thawing, Preventing deformation, breakage & clogging
  - JP2004150298A2, US6806632, JP2004192940A2, JP2004139771A2
- Sensing & System Control
  - WO04004035A3, WO04082053A1, EP1429409A1, WO04004056A1

# Interactions and Collaborations

## Supported and Participated at the DOE/LANL Workshop on Fuel Cell Operation below Freeze

- NREL supported planning and organizing the DOE Workshop on Fuel Cell Operation at Sub-Freezing Temperatures (Held on February 1-2, 2005 in Phoenix, AZ)
- Principal Investigator presented results of patent search and preliminary energy analysis at the Workshop.
- Several of the Workshop participants (including 3M, GM, and Penn State) expressed interest in the patent search and analysis.
- Participated at the brainstorming sessions for identifying research issues and a plan for implementation. Identifying system aspect as an important element.

# Responses to Previous Year Reviewers' Comments

Note: Last year, the focus was on system analysis to investigate oxygen enrichment. This year, we have focused on the fuel cell freeze issues so the effort is new.

- Comment: “Increase interactions with industry teams.”
  - We have worked with industry teams through participating and organizing the Workshop on Fuel Cell Freeze.
  - We are interacting with GM and others on the patent search.
- Comment: “Investigate more extreme environment in the next steps.”
  - We have focused on sub-freezing temperatures particularly very cold temperatures of  $-20^{\circ}\text{C}$  and below.
- Comment: “Depth of analysis of individual questions (not specific components) could improve the impact of this project.”
  - We are addressing an the important issue of rapid startup of fuel cells from sub-freezing temperatures.



# Future Work

- Remainder of FY05
  - Complete the analysis patent search
  - Prepare a report summarizing the results of patent search
  - Perform energy analysis to evaluate different rapid startup methods
  - Use system and component tools to evaluate and define various strategies for rapid cold starts
- FY06 and beyond:
  - Perform more rigorous evaluation for the “freeze start technologies and methods” using 3D PEM Fuel Cell models
  - Present results at conferences and meetings
  - Partner with industry to evaluate and implement and new approaches.
  - Perform system-wise analysis for the possible combinations of promising technologies

# Project Safety

- **There is no hazard associated with this project.**

# Publications and Presentations

- **Fuel Cell Freeze Startup and Landscape of FC Freeze Patents**, Ahmad Pesaran, LANL/DOE Workshop on Fuel Cell Operation at Sub-Freezing Temperatures, Phoenix, AZ, February 1, 2005.
- **Thermal Management Characteristics for a Fuel Cell Hybrid Vehicle Under Realistic Driving Demands**, Markel T., Haraldsson K., and Wipke. K.B. Presented at the 2003 Fuel Cell Seminar, Miami Beach, FL. November 2003
- **Analysis of Fuel Cell Powertrain Implications Using ADVISOR**  
Source: Wipke K.B., Haraldsson K., and Markel T. Presented at AVL International User Meeting, Graz, Austria. October 2003
- **Cold Start Fuel Economy and Power Limitations for a PEM Fuel Cell Vehicle**, Gurski S.D. and Nelson D.J. Presented at the SAE 2003 World Congress & Exhibition, Detroit, MI. March 2003