

EVS 21
MONACO
2 - 5 April 2005

Improving Battery Design with Electro-Thermal Modeling

Ahmad Pesaran
National Renewable Energy Laboratory
Golden, Colorado, USA

NREL/PR-540-38164
August 2005

Acknowledgments

Co-Authors

Andreas Vlahinos (AES)
Desikan Bharathan (NREL)
Gi-Heon Kim (NREL)
Tien Duong (DOE)



Sponsored by

DOE Office of FreedomCAR and Vehicle Technologies
Dave Howell (DOE)

Technical Assistance

Matt Keyser (NREL)
Mark Mihalic (NREL)



Outline

- Objectives
- Motivation
- Analysis Approach
- Examples of Analysis/Results
- Comparison with Experimental Data
- Summary & Conclusions

Objectives

General

- Develop an electro-thermal process/model for predicting thermal performance of real battery cells and modules
- Use the electro-thermal model to evaluate various designs to improve battery thermal performance.

This Study

- Predict the thermal performance of a baseline design and compare it to the performance of a next-generation design
 - Baseline: 2001 Panasonic NiMH module
 - Next generation: 2004 Panasonic NiMH module
- Verify model results with experiments (infrared thermal imaging)

Motivation for the Work

- Temperature greatly affects the performance and life (and thus warranty costs) of batteries.
- Battery thermal control/management is a must for hybrid electric vehicles under real driving conditions.
- Good battery pack thermal management starts with cells and modules that perform well thermally.
- Thermal modeling and simulation could aid in designing batteries with better thermal behavior.
- A 3-D model capturing electrical as well as thermal behavior of batteries with real geometries and details including the non-electrochemical parts was needed.

Analysis Approach

- Capturing details of a cell including non-electrochemical hardware with Finite Element Analysis.
- Estimating component resistances using geometry and materials.
- Applying voltage drop to calculate current density in components.
- Estimating resistive heating (I^2R) in each component.
- Applying electrochemical heat of reactions in the core (active parts)
- Applying heat transfer boundary conditions on cell exterior.
- Predicting temperature distribution in the cell from current density and related heat generation distribution.

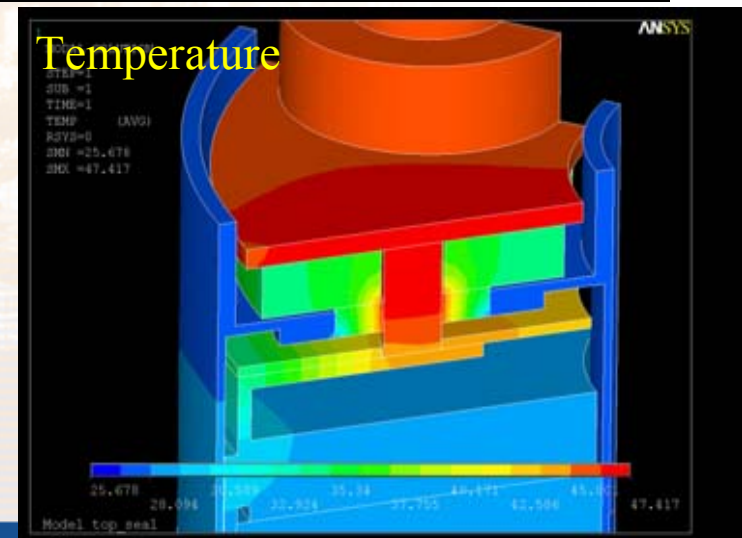
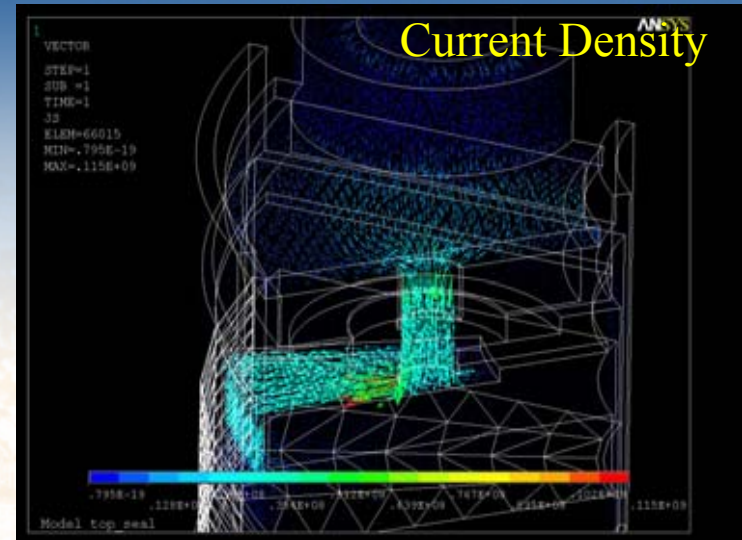

Capturing Geometry Example

Baseline: 2001 Panasonic Prismatic NiMH module in Toyota Prius

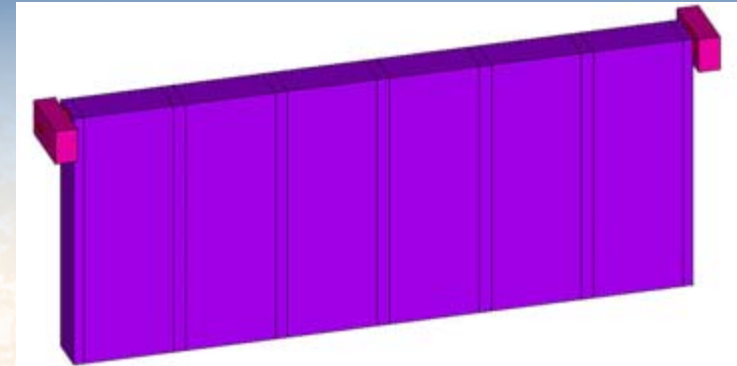
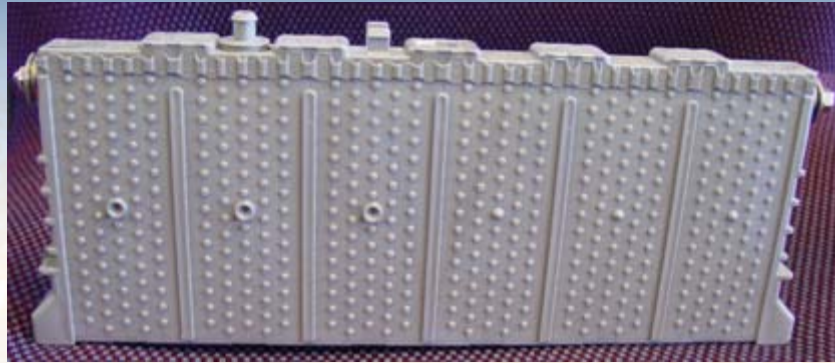

CAD/FEA model of module (exterior)

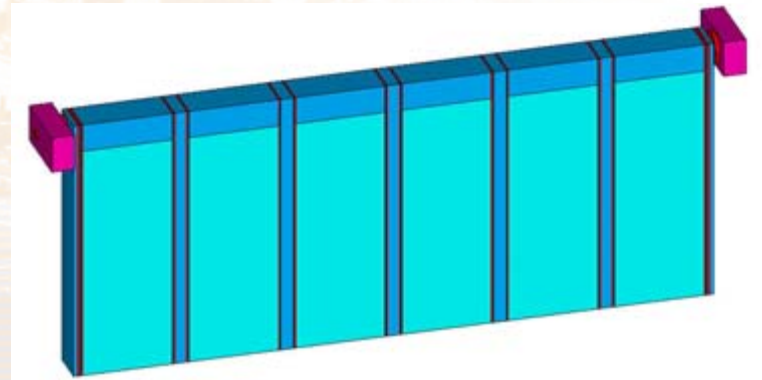

CAD/FEA model of module (case removed)

6 cells, 7.2V, 6.5Ah, 1000 W/kg module†

Used Computer Aided Design (CAD) software such as Pro-E or Finite Element Analysis (FEA) tools such as ANSYS for capturing details.

† Kojiro Ito, EVS-20 proceedings

Capturing Geometry Details

2001 Panasonic Prismatic NiMH in Toyota Prius

46 Wh/kg, 15 mOhm total DC resistance†

One weld connecting two cells in series†

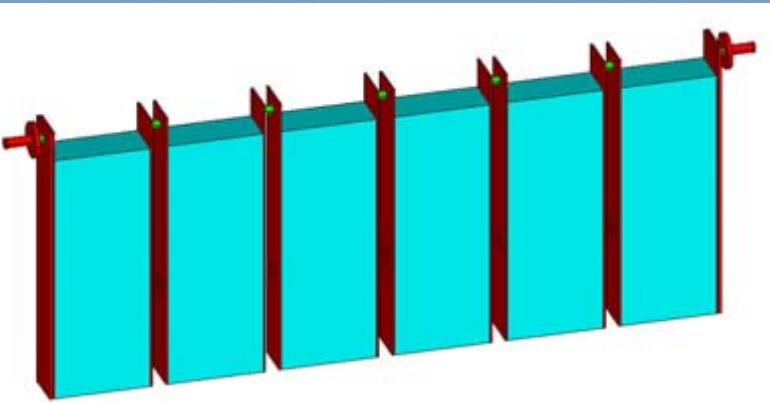

CAD/FEA model of connectors & cells

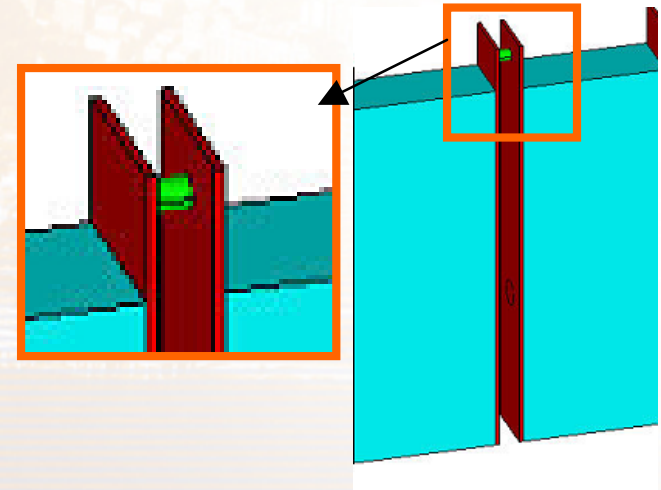
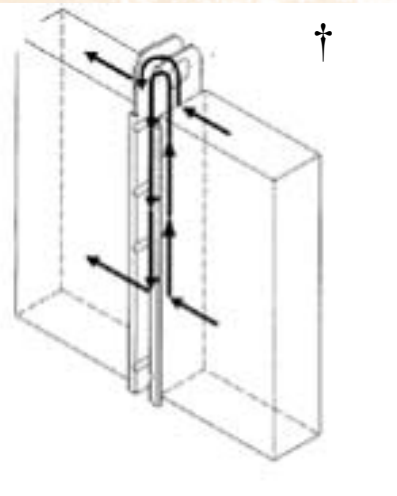

† Kojiro Ito, EVS-20 proceedings

Approximating Core Material

We assumed that the core material (electrochemically active part) is consisted of a homogenous material with average properties for resistivity and thermal conductivity, but with different properties in different directions (orthotropic)

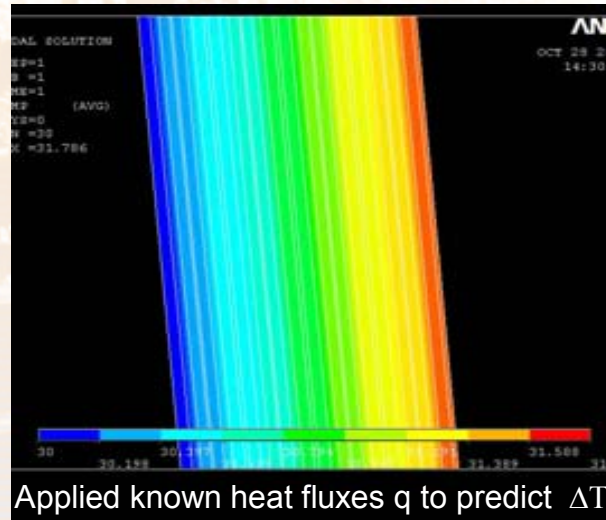
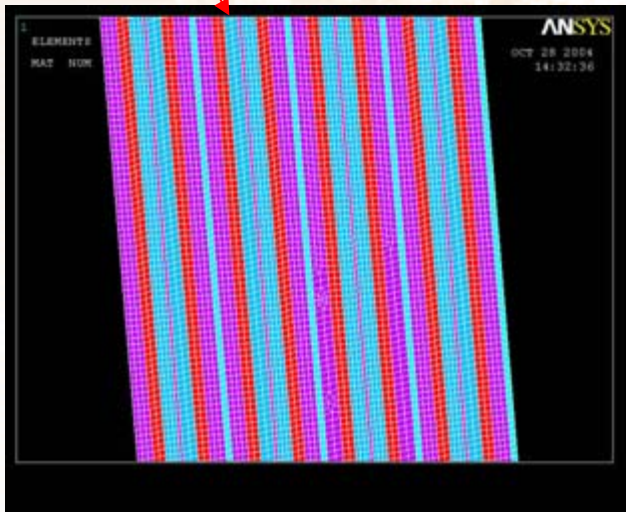
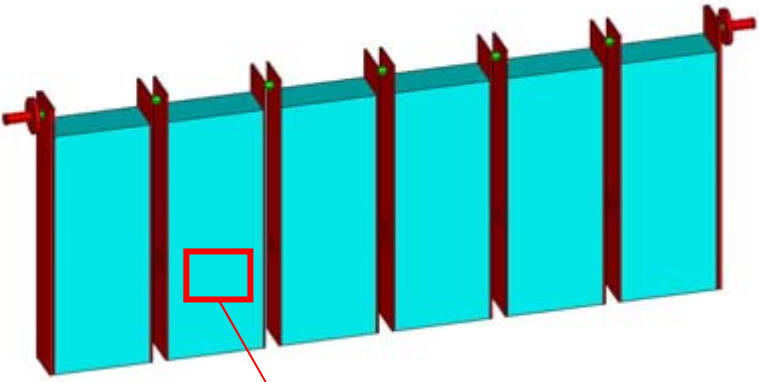

$$k_x = q * \Delta x / \Delta T$$

Used finite element analysis to calculate the effective thermal conductivity in each direction.

Voltage Distribution

(1.5 Voltage drop across terminals)

2001 Panasonic Prismatic NiMH Module

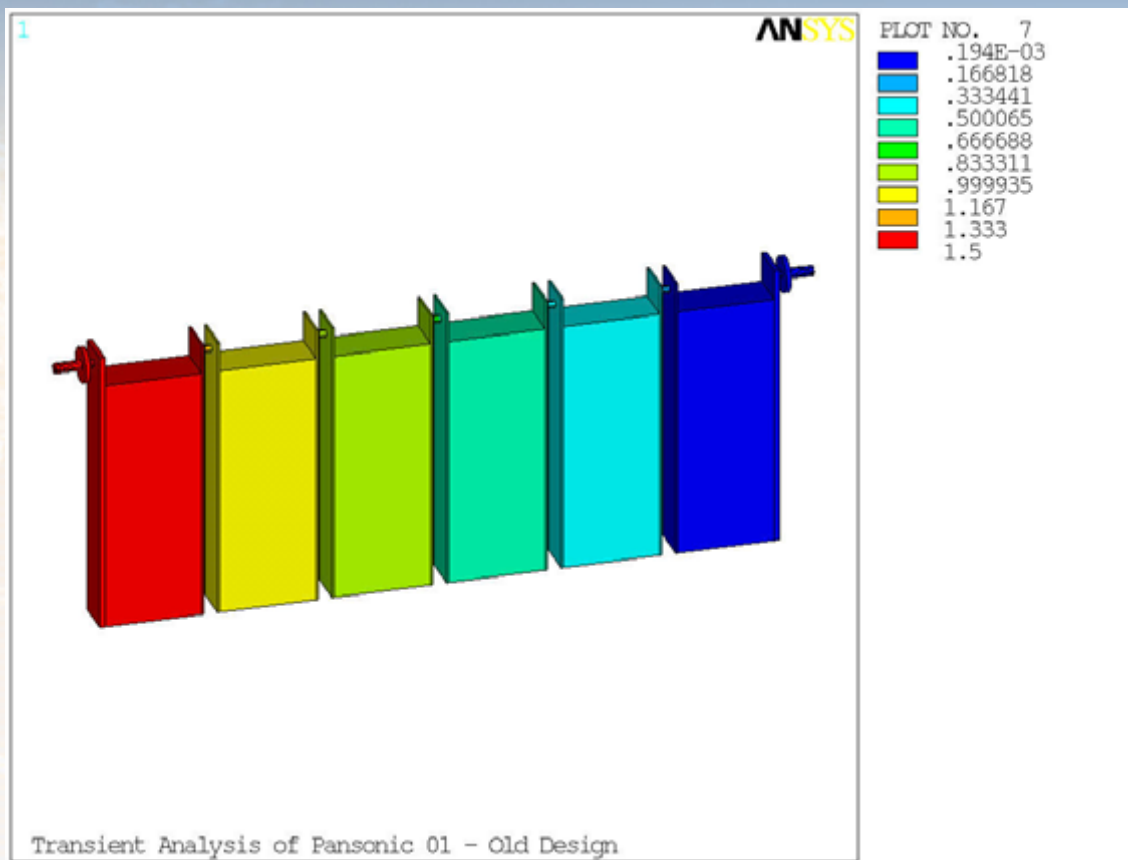

Current Density

2001 Panasonic Prismatic NiMH Module

100 A constant current discharge

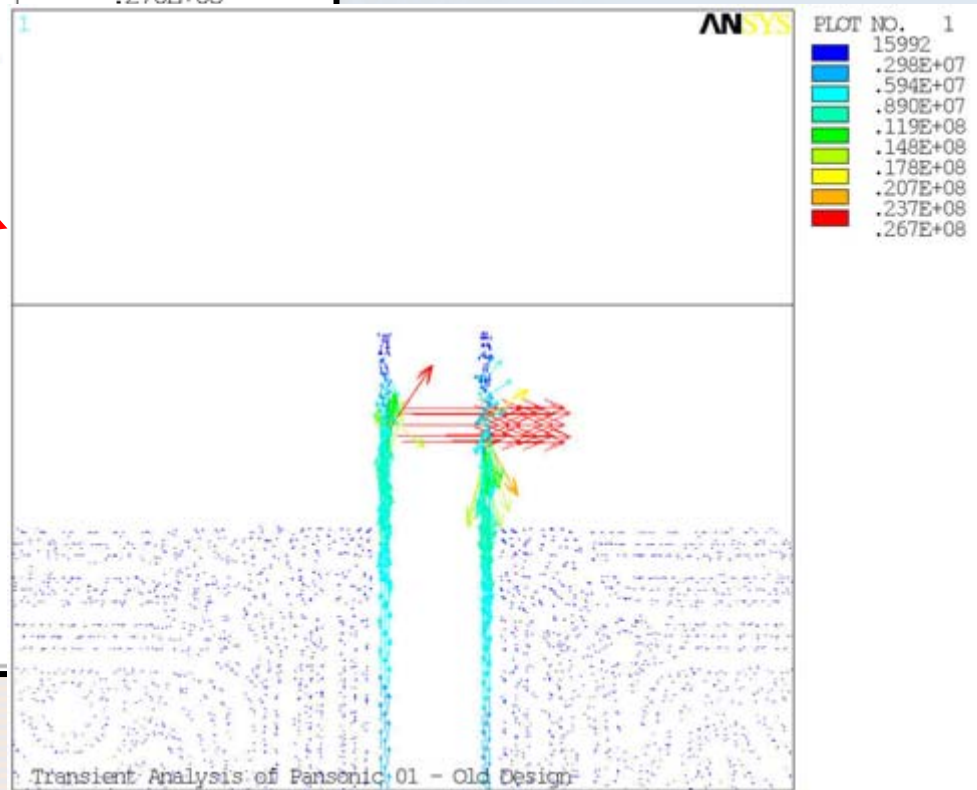
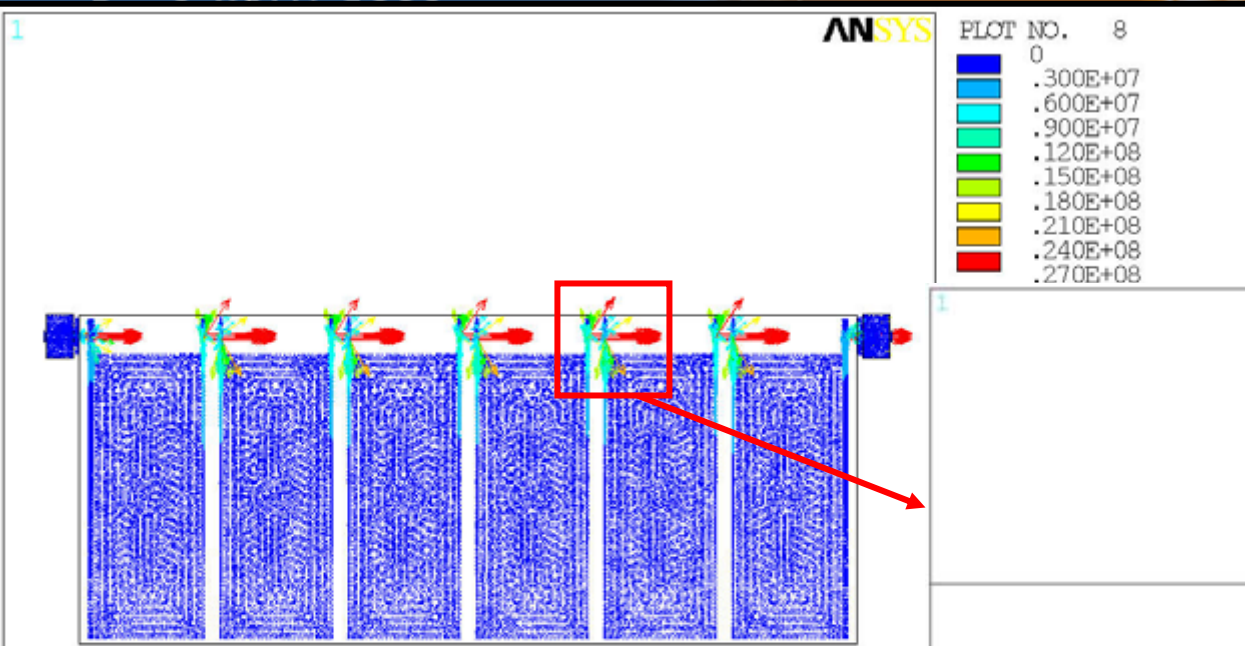

Transient Analysis of Panasonic 01 - Old Design

Transient Analysis of Panasonic 01 - Old Design

Temperature Distribution

2001 Panasonic Prismatic NiMH Module

Transient Response to 100A Constant Current Discharge

Boundary conditions: insulated on the bottom; natural convection on all other surfaces

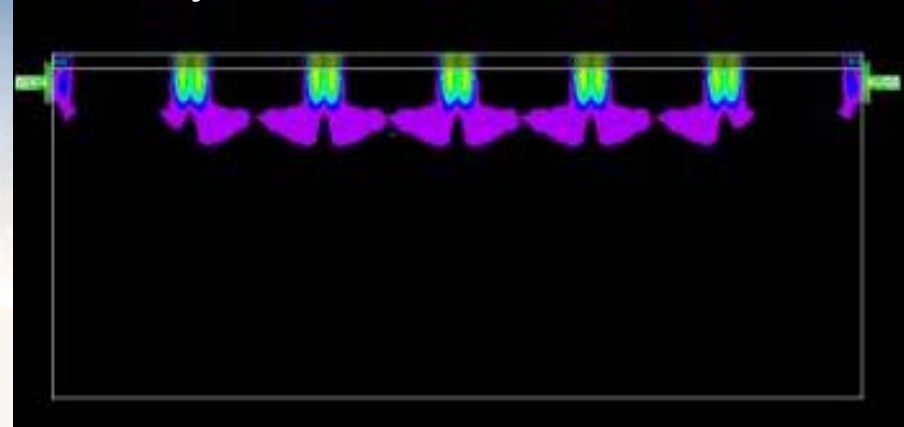

After 2 minutes of discharge

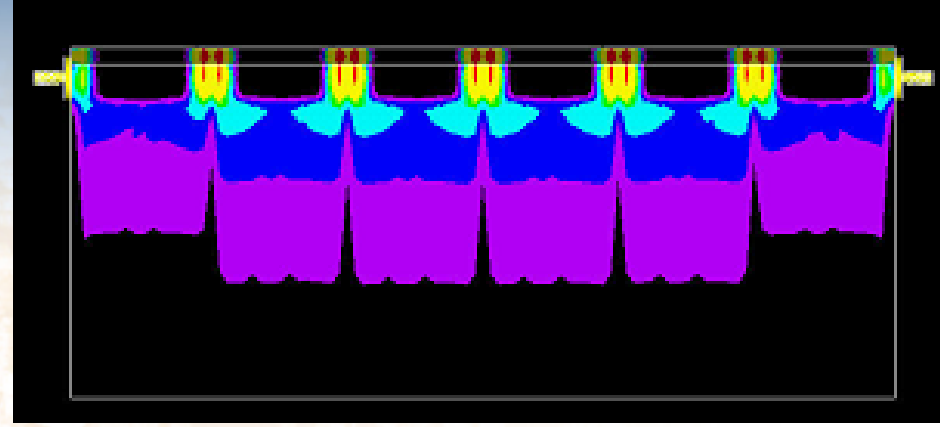

After 2.5 minutes of discharge

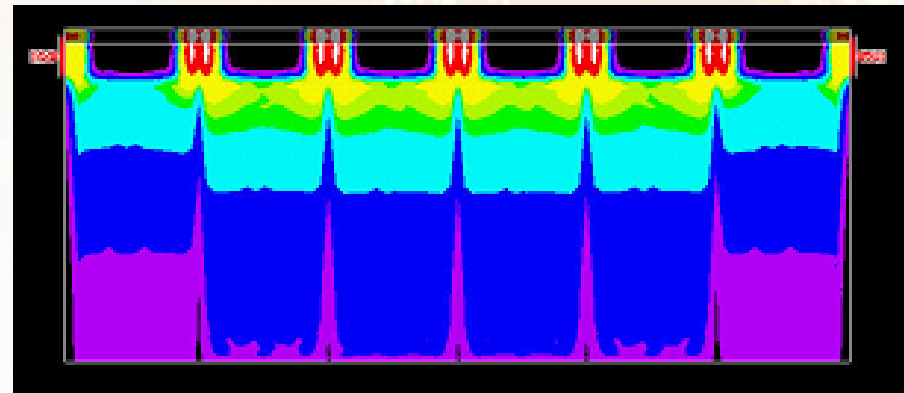

After 3 minutes of discharge

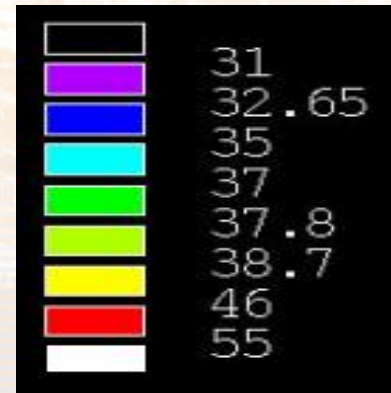

Color scale (°C)

Increasing

Heat Transfer Coefficient on five sides: $5 \text{ W/}^\circ\text{C/m}^2$

Experimental Validation Infrared Thermal Imaging

2001 Panasonic Prismatic NiMH module under 100 A Constant Discharge

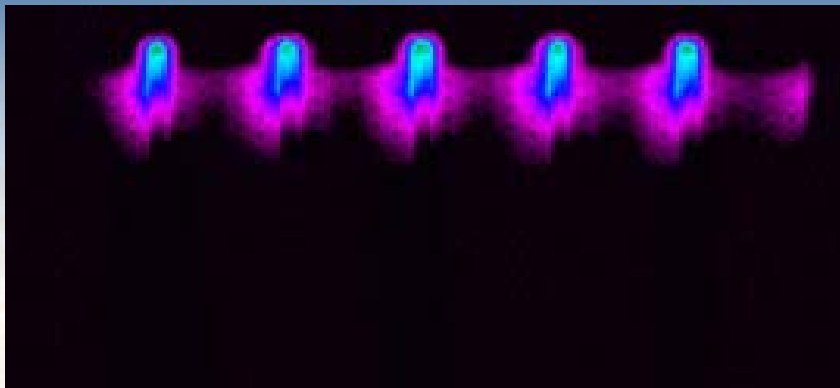

After 2 minutes of discharge

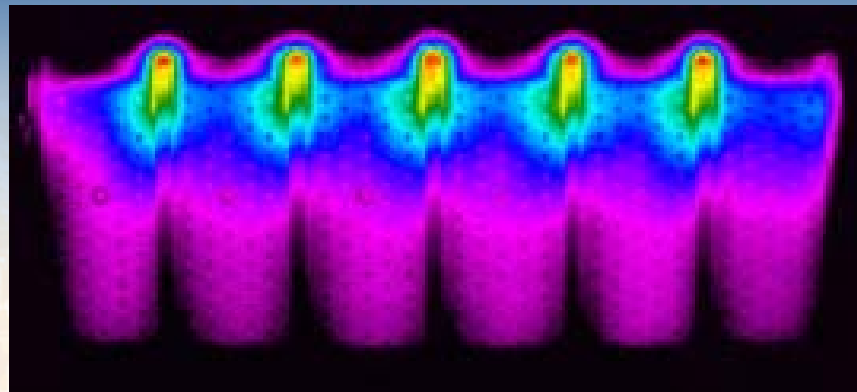

After 2.5 minutes of discharge

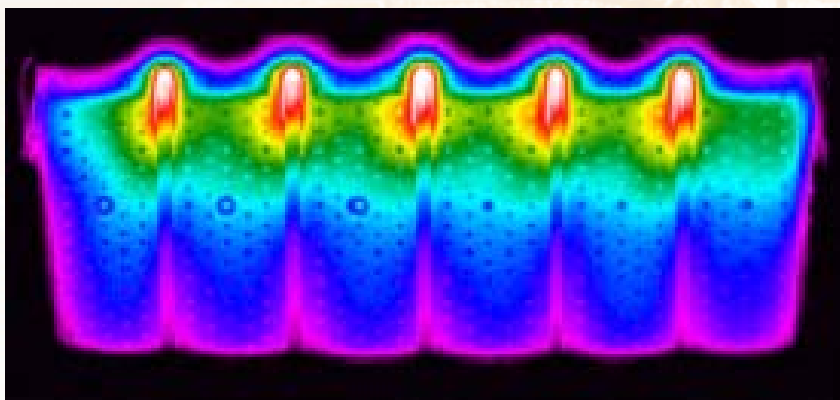

After 3 minutes of discharge

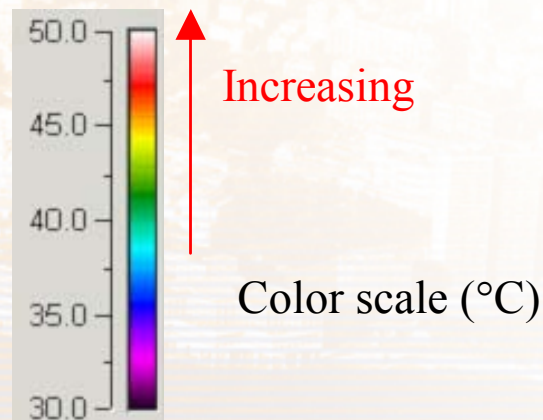

Boundary conditions: insulated on the bottom;
natural convection on all other surfaces

Qualitative Model Validation

Comparing Model Predictions with Thermal Images

Model Predictions
100 A Discharge

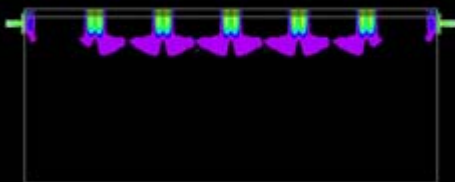

2001 Module

After
2 minutes

*>50.0°C

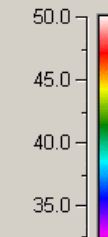

Experiment
100 A Discharge

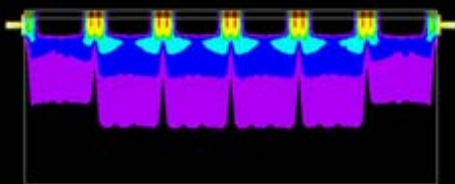
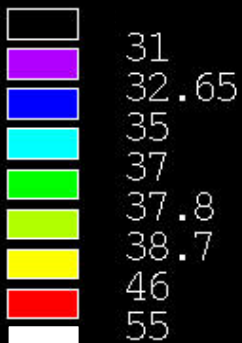
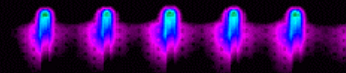

After
2.5 minutes

*>50.0°C

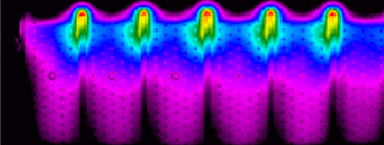
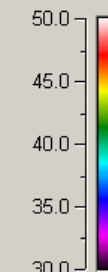

After
3 minutes

*<30.0°C

*>50.0°C

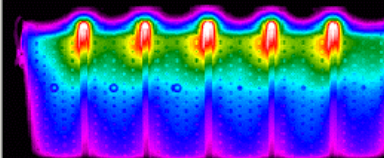
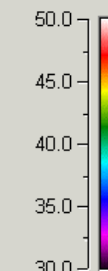

*<30.0°C

Improved Design

2004 Panasonic Prismatic NiMH Module

6 cells, 7.2V, 6.5Ah, 1300 W/kg module[†]
46 Wh/kg, 11.4 mOhm total DC resistance[†]

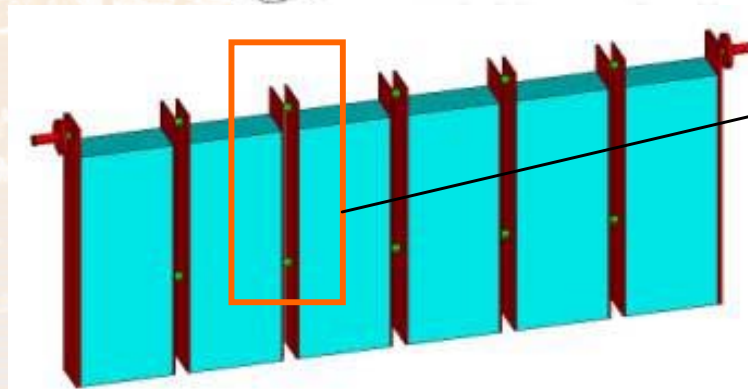
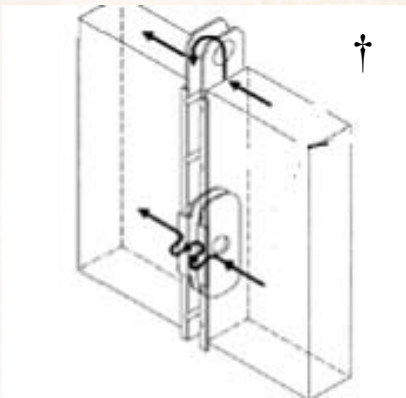
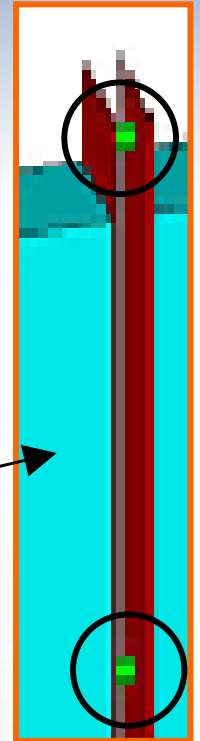
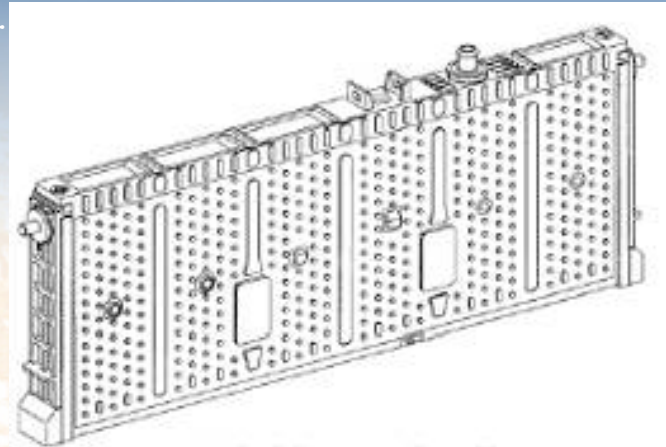
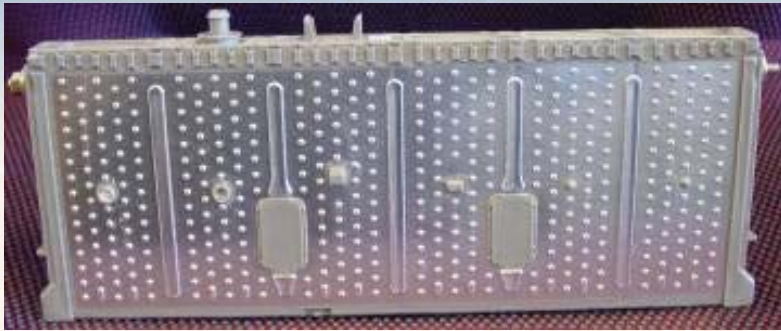

CAD/FEA model of connectors & cells

Two welds connecting two cells in series[†]

[†] Kojiro Ito, EVS-20 proceedings

Current Density

for 100 A discharge of 2004 Module

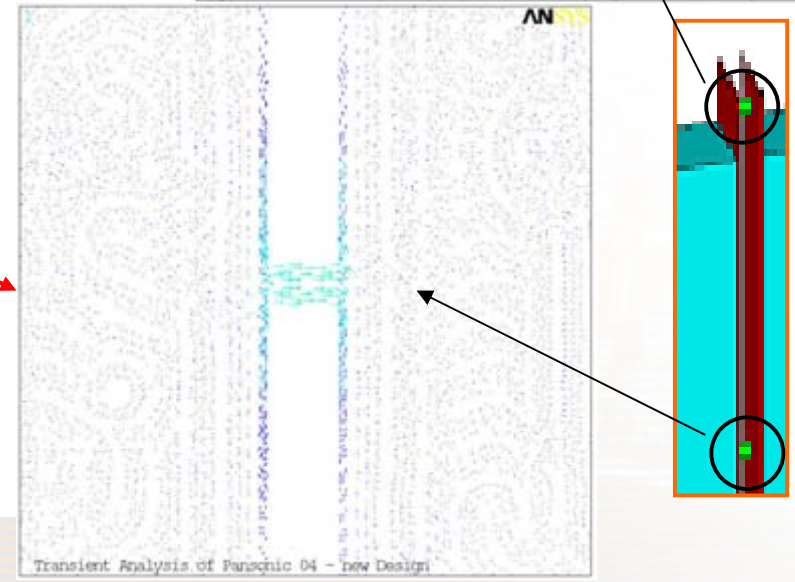
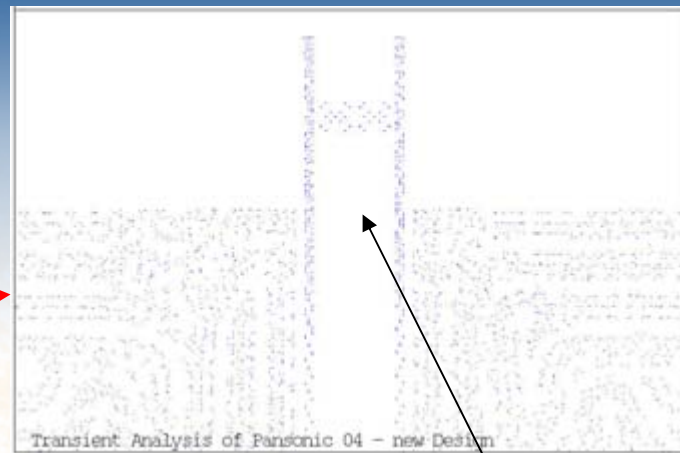
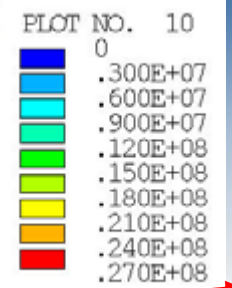
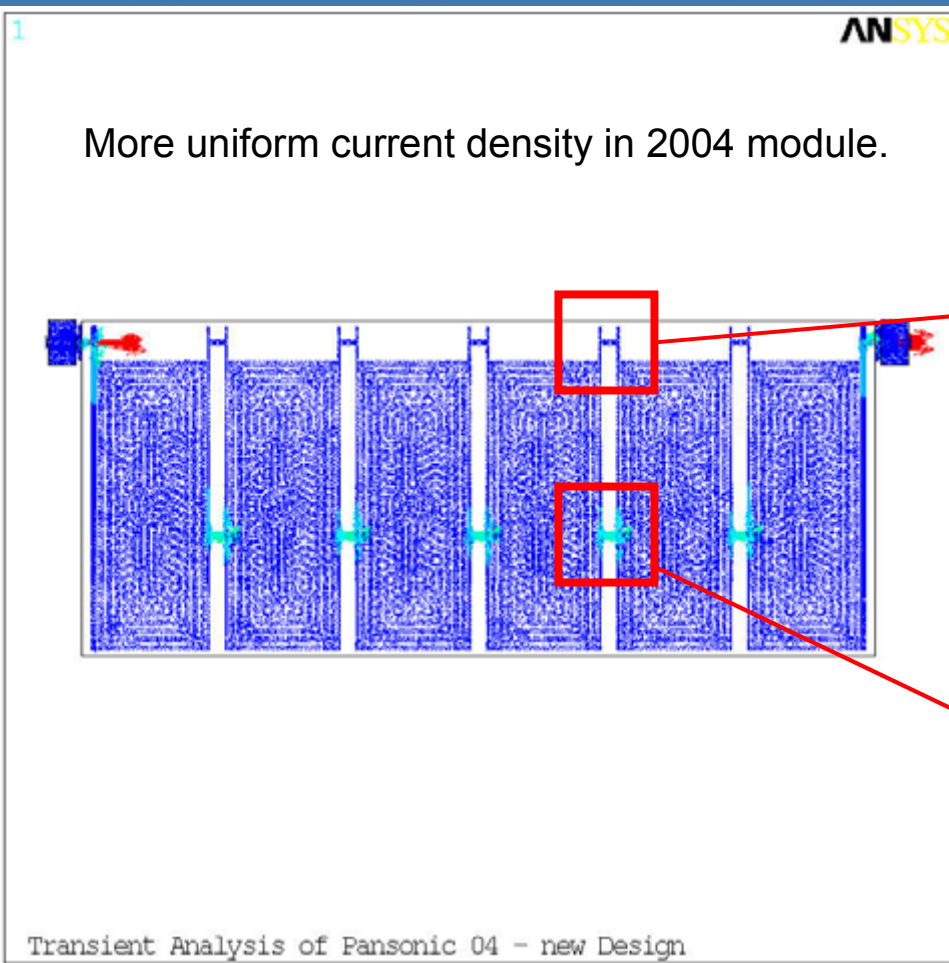

Comparison of Current Densities

2001 Module

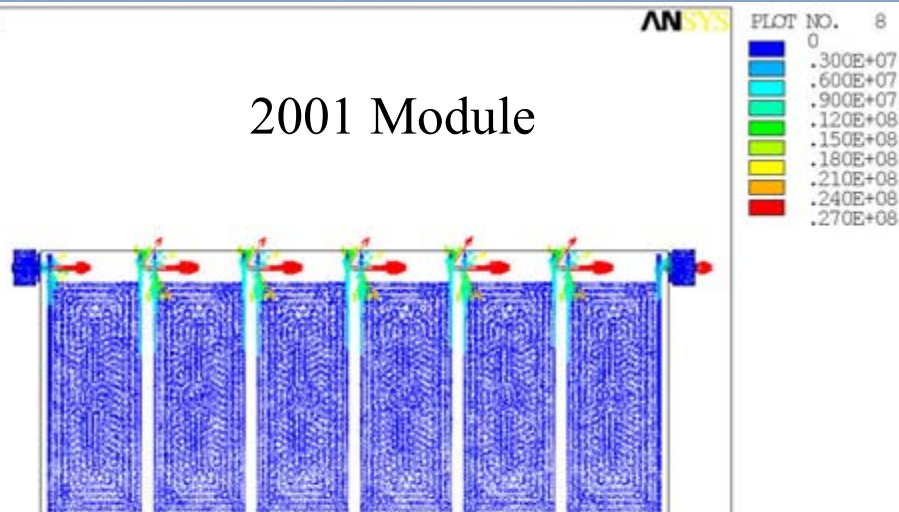

Transient Analysis of Panasonic 01 - Old Design

2004 Module

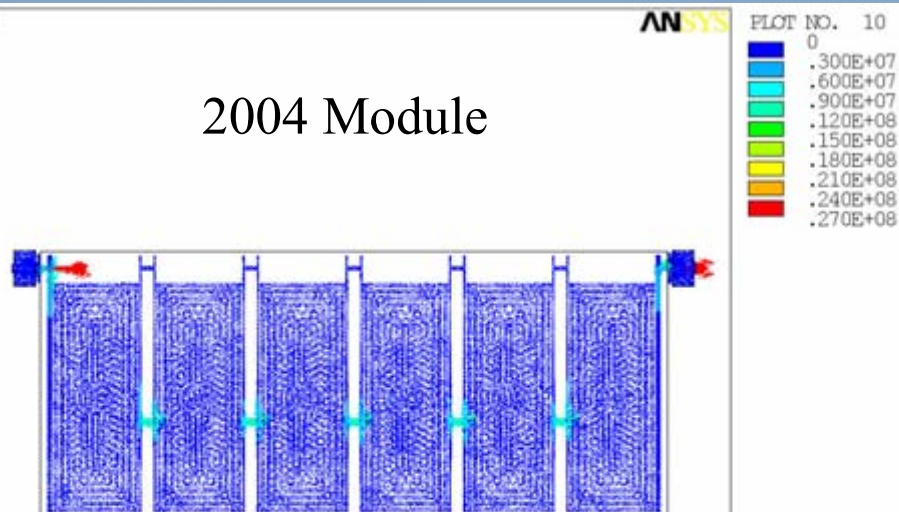

Transient Analysis of Panasonic 04 - new Design

The model predicted lower and more uniform current density in 2004 module.

Temperature Distribution

2004 Panasonic Prismatic NiMH Module

Transient Response to 100A Constant Current Discharge

Increasing time →

After 3 minutes

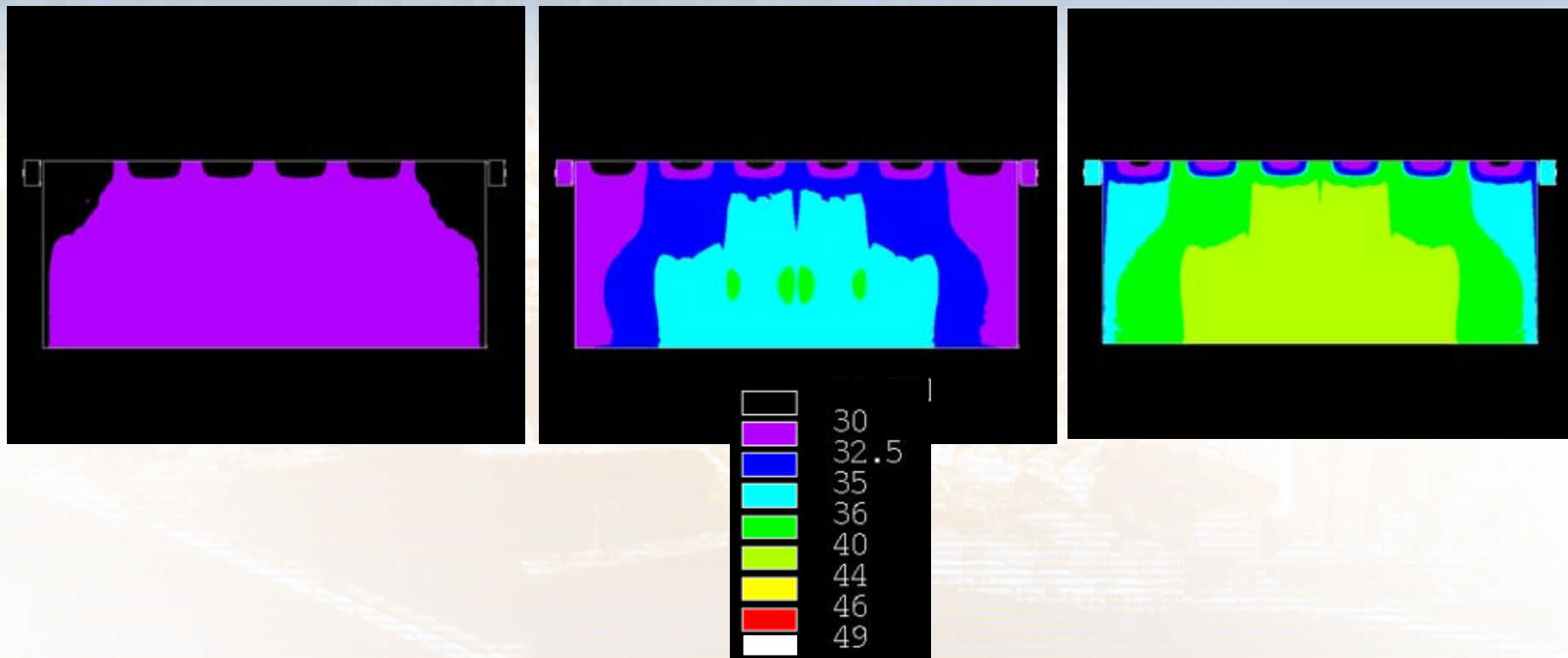

The model predicted more uniform temperature distribution in 2004 module.

Comparing Temperature Distributions (model & test)

Response at the end of to 100A Constant Current Discharge (3 min)

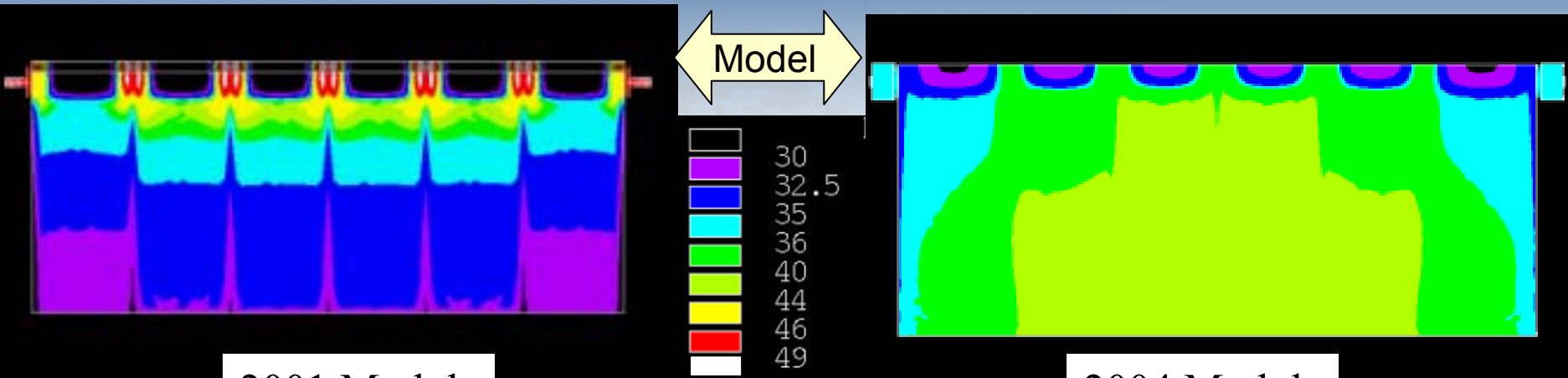

2001 Module

2004 Module

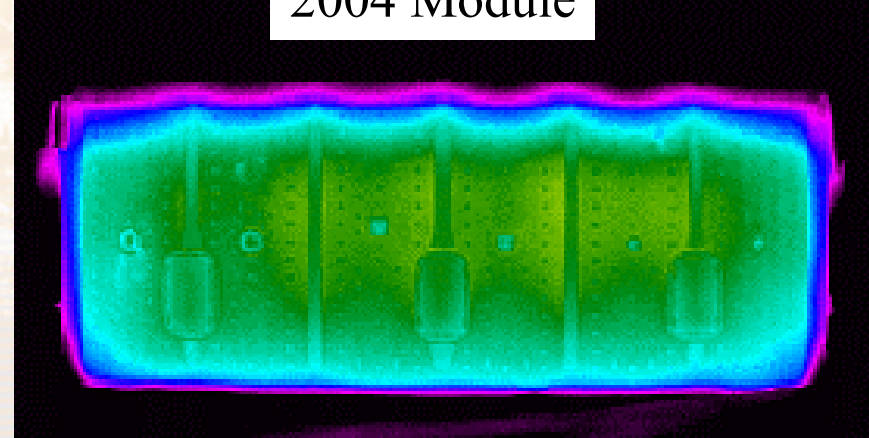
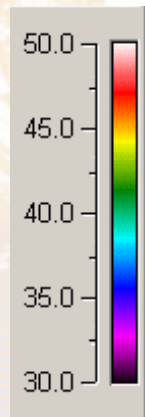
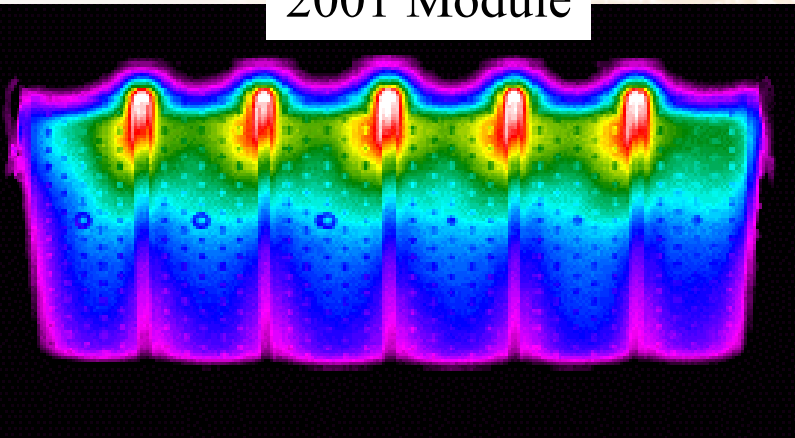

The model predicted lower and more uniform temperature distribution in 2004 module.

Summary and Conclusions

- We developed the process of electro-thermal modeling for battery cells and modules with real geometries.
- The model is used to predict the current and temperature distributions in batteries for improving designs.
- We applied the modeling approach to two generation designs of prismatic Panasonic NiMH modules.
- The model results were in good agreement of thermal imaging of real modules under 100 A constant current discharge.
- The model predicted that adding a second set of welds to interconnects could reduced the overall temperature and improve temperature uniformity. (This is what Panasonic did in their 2004 module.)
- The electro-thermal model could be applied to other chemistries (lithium ion) and any geometry (cylindrical).