

# Expert Meeting Report: Recommendations for Applying Water Heaters in Combination Space and Domestic Water Heating Systems

A. Rudd, K. Ueno, D. Bergey, R. Osser  
*Building Science Corporation*

June 2012

**This report received minimal editorial review at NREL.**

### **NOTICE**

This report was prepared as an account of work sponsored by an agency of the United States government. Neither the United States government nor any agency thereof, nor any of their employees, subcontractors, or affiliated partners makes any warranty, express or implied, or assumes any legal liability or responsibility for the accuracy, completeness, or usefulness of any information, apparatus, product, or process disclosed, or represents that its use would not infringe privately owned rights. Reference herein to any specific commercial product, process, or service by trade name, trademark, manufacturer, or otherwise does not necessarily constitute or imply its endorsement, recommendation, or favoring by the United States government or any agency thereof. The views and opinions of authors expressed herein do not necessarily state or reflect those of the United States government or any agency thereof.

Available electronically at <http://www.osti.gov/bridge>

Available for a processing fee to U.S. Department of Energy  
and its contractors, in paper, from:

U.S. Department of Energy  
Office of Scientific and Technical Information  
P.O. Box 62  
Oak Ridge, TN 37831-0062  
phone: 865.576.8401  
fax: 865.576.5728  
email: <mailto:reports@adonis.osti.gov>

Available for sale to the public, in paper, from:

U.S. Department of Commerce  
National Technical Information Service  
5285 Port Royal Road  
Springfield, VA 22161  
phone: 800.553.6847  
fax: 703.605.6900  
email: [orders@ntis.fedworld.gov](mailto:orders@ntis.fedworld.gov)  
online ordering: <http://www.ntis.gov/ordering.htm>



Printed on paper containing at least 50% wastepaper, including 20% postconsumer waste

# **Expert Meeting Report: Recommendations for Applying Water Heaters in Combination Space and Domestic Water Heating Systems**

Prepared for:

Building America

Building Technologies Program

Office of Energy Efficiency and Renewable Energy

U.S. Department of Energy

Prepared by:

A. Rudd, K. Ueno, D. Bergey, R. Osser

Building Science Corporation

30 Forest Street

Somerville, MA 02143

NREL Technical Monitor: Cheryn Engebrecht

Prepared Under Subcontract No. KNDJ-0-40337-00

June 2012

**[This page left blank]**

## Contents

<b>Definitions</b> .....	<b>v</b>
<b>Executive Summary</b> .....	<b>vi</b>
<b>1 Meeting Topic, Agenda, and Location</b> .....	<b>1</b>
<b>2 Introduction</b> .....	<b>2</b>
<b>3 Summary of Discussions</b> .....	<b>3</b>
3.1 What are the current industry understandings and experiences relative to the use of combination space and domestic water heating systems in general, and in specific related to the use of tankless water heaters? .....	3
3.2 How does cycling frequency and short-cycling affect the efficiency and life of tankless water heaters?.....	4
3.3 How important are hot water delivery problems associated with hot/cold plug flow (cold water sandwich) and trickle flow? .....	4
3.4 How much does the addition of a small, insulated, storage tank (that acts as a multiport manifold and a buffer against hot water delivery problems) affect overall efficiency, cost, and maintenance?.....	5
3.5 In order to maximize condensing operation, heating coil water supply temperature should be as low as possible, but what are the limits of that to provide comfortable air delivery? What are the related issues and recommendations related to hydronic coil sizing and increased air handler and circulator runtime?.....	5
3.6 What are the issues and effective solutions related to mineral scale in piping and heat exchangers, and clogging of inlet strainers, requiring maintenance? .....	6
3.7 What are the economic advantages and disadvantages of combination systems versus traditional furnace and water heater designs or versus traditional boiler and indirect water heater designs? .....	7
<b>4 Summary of Gaps and Barriers</b> .....	<b>9</b>
4.1 What new testing, field studies, and standards work are needed to fill important knowledge gaps or barriers that could impede efficient and reliable combination system applications? .....	9
<b>5 Next Steps</b> .....	<b>11</b>
<b>Appendix A: Meeting Agenda</b> .....	<b>12</b>
<b>Appendix B: Attendant List</b> .....	<b>18</b>
<b>Appendix C: Presentations</b> .....	<b>20</b>

## Definitions

BSC	Building Science Corporation
CEE	Center for Energy and Environment
Combination System	combination space and domestic water heating system
DHW	Domestic Hot Water
gpm	Gallons per Minute
NRC	Natural Resources Canada
SAT	Supply Air Temperature
TWH	Tankless Water Heater
SWH	Storage-Type Water Heater

## Executive Summary

The topic of this meeting was “Recommendations for Applying Water Heaters in Combination Space and Domestic Water Heating Systems.” Presentations and discussions centered on the design, performance, and maintenance of these combination systems, with the goal of developing foundational information toward the development of a Building America Measure Guideline on this topic. The meeting was held at the Westford Regency Hotel, in Westford, Massachusetts, on July 31, 2011. As residential building enclosure improvements continue to drive heating loads down, being able to use the same water heating equipment for both space heating and domestic water heating (combination systems) becomes very attractive from a cost and space-saving perspective. Before committing to wide-scale implementation of such combination space and domestic water heating systems for high performance buildings, whether new or retrofit, design decisions affecting performance, maintenance, and occupant acceptability need to be well understood. Current performance rating procedures for this type of water heating system, and its many variants, are inadequate to provide convincing prediction of estimated savings. In order to be assured of meeting the Building America savings goals, results of laboratory and field testing results are shared to help with verification of energy savings and their installed persistence.

Discussions about this topic were applicable to single- and multifamily residential buildings, both new and retrofitted. From a performance point of view, combination systems utilizing tankless water heaters are of particular interest because of the high heating capacity and low standby losses. However, consistency of supplied water temperature at low flow rates and during rapid on/off usage patterns is a concern. Storage-type water heaters reduce or eliminate those concerns, but have high standby losses. Adding a small, external, well-insulated storage volume to tankless water heater combination systems may provide a high value solution, but that needs to be better understood. Tankless water heaters also have more complex designs and water heating strategies that can impact efficiency at different flow rates and temperatures. Intricate flow measuring and flow controlling components need to be protected from potential damage by foreign particles that may be in the water, but those protection filters can require unacceptable cleaning intervals. Combination systems generally require heating and storing water at a higher temperature than required for domestic hot water only. The higher the temperature of the stored water, the greater the potential for mineral scale and galvanic corrosion. All of these factors need to be better understood before firm recommendations can be made relative to wide implementation of these systems.

Presentations and discussions covered eight key questions ranging from equipment and system design strategies, to laboratory and field tested performance, occupancy interactions and hot water use profiles, maintenance issues, practical plumbing perspectives, rating standards, and gaps and barriers to efficient wide-scale implementation.

BSC will continue to monitor two combination systems in New York and expects to add another site in Pennsylvania soon. By building on past experience, the collected monitoring data, and the information generated by this expert meeting, BSC will draft a Measure Guideline for implementing combination space and domestic water heating systems in 2011. It is expected that this document will continued to be updated and improved as more is learned.

## **1 Meeting Topic, Agenda, and Location**

The topic of this meeting was “Recommendations for Applying Water Heaters in Combination Space and Domestic Water Heating Systems.” Presentations and discussions centered on the design, performance, and maintenance of these combination systems, with the goal of developing foundational information toward the development of a Building America Measure Guideline on this topic.

The meeting was held at the Westford Regency Hotel, in Westford, Massachusetts, on July 31, 2011. The full meeting agenda is provided in Appendix A.

A list of the meeting attendees along with their contact information is provided in Appendix B.



## 2 Introduction

As residential building enclosure improvements continue to drive heating loads down, being able to use the same water heating equipment for both space heating and domestic water heating (combination systems) becomes very attractive from a cost and space-saving perspective. Before committing to wide-scale implementation of such combination space and domestic water heating systems for high performance buildings, whether new or retrofit, design decisions affecting performance, maintenance, and occupant acceptability need to be well understood.

Current performance rating procedures for this type of water heating system, and its many variants, are inadequate to provide convincing predictions of estimated savings. In order to be assured of meeting the Building America savings goals, results of laboratory and field testing results are shared to help with verification of energy savings and their installed persistence.

Discussions about this topic were applicable to single- and multifamily residential buildings, both new and retrofitted. From a performance point of view, combination systems utilizing tankless water heaters (TWHs) are of particular interest because of their high heating capacity and low standby losses. However, consistency of supplied water temperature at low flow rates and during rapid on/off usage patterns is a concern. Storage-type water heaters (SWHs) reduce or eliminate those concerns, but have high standby losses. Adding a small, external, well-insulated storage volume to TWH combination systems may provide a high value solution, but that needs to be better understood. TWHs also have more complex designs and water heating strategies that can impact efficiency at different flow rates and temperatures. Intricate flow measuring and flow controlling components need to be protected from potential damage by foreign particles that may be in the water, but those protection filters can require unacceptable cleaning intervals. Combination systems generally require heating and storing water at a higher temperature than required for domestic hot water (DHW) only. The higher the temperature of the stored water, the greater the potential for mineral scale and galvanic corrosion. All of these factors need to be better understood before firm recommendations can be made relative to wide implementation of these systems.

### 3 Summary of Discussions

Discussions occurred during and after each of the seven presentations (the presentations are provided in Appendix C). A summary of those discussions is given here in the applicable context of the key questions established before the meeting.

#### 3.1 What are the current industry understandings and experiences relative to the use of combination space and domestic water heating systems in general, and in specific related to the use of tankless water heaters?

Bosch sees condensing combination heating systems as ideal for radiant floor heating applications because of the lower temperature water required (98°–120°F), the long cycle times, and the simple controls. DHW priority control is not needed in combination systems used for radiant floor heating, because it is inherent in the system, considering that the large pressure drop from mains pressure to open tap will take most of the flow compared to the pressure developed by a 2 gpm circulator. Rinnai and Bosch see DHW priority as necessary for hydronic air handler combination systems to avoid delivery of heating supply air below 100°F, and to avoid problems with the heating circulator running without a full pipe of water, which can occur if the circulator is above the domestic water taps. Rinnai shuts off the heating circulator when an inline flow sensor senses less than 1 gpm in that loop.

Some installers try to avoid installing a mixing valve by keeping the TWH set point temperature at 120°F. Rinnai's testing shows that a mixing valve is necessary to avoid unacceptably large upswings and drops in water temperature at a shower when heating is activated and deactivated. In a system without a mixing valve, with the TWH set point at 120°F and the shower adjusted to 105°F, there was a 4°F upswing at the shower when heating was activated and a 6°F drop when heating was deactivated. With a pressure balancing mixing valve set at 120°F, the water heater set point temperature at 140°F, and the addition of a small inline buffer volume (1.5 in. diameter by 12 in. long pipe, or 1.5 cup), there is no significant change in delivered water temperature at a 105°F shower at the beginning or end of a heating call. Assuming 50 ft of ¾-in. pipe (about 1 gal) in the piping from the water heater to the shower, the 1.5 cup buffer volume does not change the roughly 1 minute wait time to send hot water to the shower from a cold start. The buffer device needs to be well insulated to avoid efficiency loss (Rubatex or Armaflex type insulation wall thickness at least half the pipe diameter). Supplying 140°F water to the hydronic air handler yielded a 118°F supply air temperature (SAT) and about 105°F return water temperature. Ongoing testing may allow further optimization for condensing efficiency, i.e. moving the TWH set point temperature down with the goal of 100°F return water temperature.

A commenter described a resonant frequency type humming noise problem with TWHs. This can be a symptom of TWH exhaust air recirculating back to the unit with the incoming combustion air. In this case, a cold climate kit (long-nose snout) may be needed to better separate the two air streams.

Testing by Steven Winter Associates has indicated that TWH efficiency changes with firing rate and water temperatures. Low firing rates seem to result in lower efficiency. Bosch noted that this is due to a common TWH approach of feeding a single segmented burner with several gas valves to modulate capacity. To keep efficiency high at low firing rates, Bosch modulates capacity by

turning any of four burners either full on or full off. In this way, when any burner is operating, it is always operating at full efficiency with the proper air/fuel mix across the entire burner. However, this approach causes the Bosch units to have a higher minimum firing rate (19 kBtu/h) than other units (15 kBtu/h), which means that the heater may not turn on at low flow rates and elevated entering water temperature (>70°F). This is especially problematic when trying to use solar preheated water, but it can also be a problem in southern climates where the entering water main temperature may be 75°F or higher. A commenter noted that he has this problem with a TWH in his Houston home. He has found that he has to increase water demand beyond what is possible with a low flow showerhead to get the TWH to turn on. He accomplishes this by turning on the hot sink faucet while taking a shower. In a solar preheat application, Building Science Corporation (BSC) solved this problem by using a TWH to keep a 6-gal insulated storage tank heated to a controlled set point temperature rather than bringing the preheated water through the TWH.

Manufacturers have a real health concern about water stagnation in systems where the heating circulator does not run for 6 months. A pump cycling timer is needed to avoid that problem. A scald prevention mixing valve is a necessary safety component in any DHW system controlled to above 120°F.

### **3.2 How does cycling frequency and short-cycling affect the efficiency and life of tankless water heaters?**

Short cycling can lead to customer dissatisfaction and premature failure of component parts. Bosch defined short cycling as run times shorter than 10 seconds. Many DHW draws are for less than 10 seconds, and it is questionable whether any usable energy is delivered in that case. No equipment rating standards require testing for that. For combination systems with TWHs, field data taken by BSC have shown a 10 times greater cycling rate for a system without a small (12-gal) storage tank compared to a system with it. It is obvious that equipment life would be significantly impacted by such a large difference in on/off cycling of moving parts, but any quantification of that is not widely known.

With little storage and many short DHW draws, much of the TWH system's electricity consumption can be for pre- and post-purge operation.

### **3.3 How important are hot water delivery problems associated with hot/cold plug flow (cold water sandwich) and trickle flow?**

When THWs were first introduced in the United States, the water flow rate threshold for heater activation was about 0.7 gpm or higher. The industry quickly raised concerns about the unavailability of hot water at commonly lower flow rates. Manufacturers have been responding to those concerns by lowering the activation threshold, which is now as low as 0.4 gpm, and some units can continue to operate as low as 0.26 gpm after it has already been activated at the higher threshold. This has significantly reduced the extent of low flow issues.

Bosch and Rinnai acknowledge problems associated with maintaining consistent hot water supply temperature with TWHs because of hot/cold plug flow and trickle flow (less than activation flow). Both recommend designs that include additional stored water volume to overcome that. Bosch described an unpowered (passive) tank and a powered (active) tank option.

The powered tank option is the most robust in solving the problem but requires more energy. The unpowered option increases hot water delivery time due to the larger volume of cooled-off water when there has not been DHW or heating demand for some time.

High capacity storage-type water heaters (SWHs) used in combination systems eliminate the cold water sandwich and trickle flow problems associated with TWHs, but high jacket heat loss and long runtimes to condensing operation reduce efficiency. A condensing SWH starts condensing after about 10 to 15 minutes of operation; a condensing TWH starts condensing operation almost immediately because cool incoming water cools the combustion exhaust.

### **3.4 How much does the addition of a small, insulated, storage tank (that acts as a multiport manifold and a buffer against hot water delivery problems) affect overall efficiency, cost, and maintenance?**

BSC is in the early stages of collecting adequate field data to understand the question of efficiency for a system with a 12-gal insulated electric water tank as the storage volume. The additional cost of an off-the-shelf 6- to 12-gal insulated electric water heater storage tank is about \$200. If a bronze or stainless steel circulator is used to circulate water through the TWH, that would add \$300 to \$400.

The Center for Energy and Environment (CEE) has been conducting laboratory testing that shows that the efficiency deficit is large for at least one TWH product with a small, underinsulated integral storage/buffer tank.

Rinnai has recently worked out a design recommendation for adding a small, field-installed storage volume, but its effect on efficiency has not been evaluated and would depend largely on how well the storage volume was insulated.

The A.O. Smith 100 kBtu/h Vertex product with condensing heat exchanger, direct-vent (two-pipe sealed combustion), and 50-gal glass-lined tank is probably the best-known overall competitor (based on capability and cost) to a combination system with TWH and a small storage volume.

Insulating all piping and storage components of any water heating system is vitally important. Otherwise, large inefficiency from heat loss will result. One TWH combination system that CEE tested had a 2-gal internal storage tank, but it and other piping components were so poorly insulated that it had about the same idle heat loss (400 Btu/h, costing about \$40/yr) as other 50-gal SWHs (tank) tested.

### **3.5 In order to maximize condensing operation, heating coil water supply temperature should be as low as possible, but what are the limits of that to provide comfortable air delivery? What are the related issues and recommendations related to hydronic coil sizing and increased air handler and circulator runtime?**

A Rinnai chart indicated that condensing TWH efficiency increases from about 87% at 130°F return water temperature to about 94% at 80°F return water temperature. To maximize condensing operation, pump flow controls can be employed to control return water temperature. In other words, if the return water temperature is too high to achieve efficient condensing

operation, the pump flow could be automatically reduced. But that forces a tradeoff with heating SAT, because as the pump flow and the return water temperature drops, so does the SAT and the hydronic air handler efficiency. Air source heat pumps often operate at SATs below 100°F, geothermal heat pumps often operate at SATs around 105°F, and whole-house air circulation strategies effectively move room temperature air, so the SAT problem can be managed, but proper duct design and appropriate supply grille design and placement are critical to avoid cool air complaints.

Larger hydronic coils can also be used to lower return water temperature without reducing pump flow or air handler efficiency, but that has an economic tradeoff of higher equipment cost. CEE testing indicates that hydronic air handler coil sizes need to be much larger to achieve low enough return water temperature to provide consistently high condensing efficiency. CEE data, averaged for a group of combination systems with condensing water heaters, showed that total heating plant efficiency (gas and electric) was about 82% with 120°F return water temperature and about 91% with 80°F return water temperature.

A comprehensive control strategy needs to be developed and tested to optimize the control of heating pump flow, air handler flow, and TWH heating output, to control on heating water return temperature, heating SAT, and DHW supply temperature to better optimize and monitor efficiency and comfort of specific combination systems. This would require using expensive variable-speed components and additional temperature and flow sensors.

### **3.6 What are the issues and effective solutions related to mineral scale in piping and heat exchangers, and clogging of inlet strainers, requiring maintenance?**

Traditionally, TWHs have been mostly used in open systems for DHW only. Any time you cause any type of closed system recirculation, such as when water is circulated to keep hot water more quickly available at the taps, or such as when water is circulated for space heating, anything generated inside the system (e.g., anode rod decay or mineral precipitate), will clog the inlet strainer that is designed to protect flow measuring and flow controlling components. In BSC's field experience, the inlet strainer cleaning interval can range from days to months without a large pre-strainer, and extended to annual service with a large pre-strainer. The pre-strainer used in BSC projects has a 200 micron stainless steel screen, compared to the 238-micron screen in the Rinnai TWH's inlet strainer. Bosch uses a 300-micron inlet strainer.

Rinnai TWHs use a heating method sometimes called *flash heating*. That control strategy sends only a portion of the total water flowing through the unit through the heat exchanger; the rest is bypassed and remixed at the unit outlet. The portion going through the heat exchanger is heated to 150°–185°F. This is done to prevent condensation and corrosion in a noncondensing heat exchanger when the water is being heated to less than 120°F. The lower the requested set point temperature, the more the water overheats. Generally the heat exchanger temperature should be at least 125°F to avoid condensation. A set point temperature of 140°F is a sweet spot for the Rinnai system efficiency and delivered temperature consistency.

It is known that the hotter the water, the more mineral precipitate (mainly calcium carbonate) will drop out of solution. This will contribute to scale formation, and BSC's field experience

indicates that it contributes to clogging of the water heater's inlet strainer screen whenever recirculation is active.

Navien is a TWH manufacturer that does not use the flash heating method. Navien uses a stainless steel heat exchanger and essentially all of the water flowing through the unit flows through the heat exchanger where it is heated only as much as needed. This may be an important factor in extending inlet strainer cleaning intervals. Future research should explore this in more detail.

Bosch believes that the inlet strainer on its equipment can be removed after the first week or so of operation after installation or after any new plumbing is done. The basis for this is that, in its experience, the potentially damaging foreign materials in the system are generally bits of copper, thread tape, and thread sealant from the piping installation, and after those materials are captured and removed, the strainer is no longer needed. Perhaps other manufacturers are being too conservative with either the micron size of the inlet strainer, or in requiring the continued use of the strainer at all. If that is so, perhaps the only problem that BSC has experienced with these combination systems to date, that of clogged inlet strainers, could be easily resolved. Although a smaller Y strainer may be adequate in some cases, BSC has resorted to adding a large-capacity, stainless steel strainer ahead of the TWH filter screen. However, this adds about \$150 material cost, another 1/3 gal of storage to the system, and another fixture to insulate.

It is unlikely that a combination system would increase scale risk over that of a TWH system alone, but because of the recirculation involved, BSC has found inlet filter clogging to be a serious problem that must be addressed upfront in the design.

BSC found that a Clearwave electronic water conditioner can remove calcium carbonate scale in piping and prevent new scale from forming. Rinnai TWHs sense when scale is affecting efficiency by more than 5% and display a fault condition if this occurs. The Rinnai noncondensing TWH combination system where BSC applied the electronic water conditioner has gone through four years without a scale fault condition. Excess scale can cause a condensing TWH to be noncondensing.

Especially with the higher water temperature common with combination systems, it is important to use plastic-lined galvanized nipples for connecting to a steel tank. Unlined nipples will scale quickly, reducing and sometimes blocking water flow. Scale can also break loose and contribute to clogging the TWH inlet strainer. In an attempt to deal with problematic hard water issues, some people oversoften the water, which removes a useful thin protective layer of scale formation in copper pipes and hastens thinning of the relatively soft metal by water erosion. Hot water recirculation systems also wear out copper pipes and TWHs. It is far better to use good piping design and pipe insulation to reduce hot water delivery wait times.

### **3.7 What are the economic advantages and disadvantages of combination systems versus traditional furnace and water heater designs or versus traditional boiler and indirect water heater designs?**

Contractor-installed cost for a New York State Energy Research and Development Authority combination system retrofit project was \$3,500 per system for two identical systems in a two-family house. Installed combination systems using a condensing TWH, with or without a small

external insulated storage volume, can cost less than half traditional boiler and indirect water heater designs. The cost differential is less when comparing combination systems to traditional furnace and water heater designs, but it is still in the favor of combination systems as long as the water heating efficiency is comparable for both.

Contractor bids for the CEE project, for a group of four different installed combination systems, by two different contractors, showed that costs varied from about \$6,000 to \$10,000 per system.

Based on studies done by Natural Resources Canada, a condensing TWH must be used for a combination system to achieve the same or better overall efficiency compared to a condensing furnace and a 0.62 energy factor water heater in cold climates.

Estimates of system cost comparisons show:

- Lowest cost category: hydronic air handler + condensing SWH and hydronic air handler + condensing TWH
- Middle cost category: condensing furnace and condensing water heater
- Highest cost category: hydronic air handler + condensing boiler and hydronic air handler + solar preheat.

A commenter questioned whether combination systems will save energy and capital cost. If the systems are not bulletproof, there should be a hesitation to recommend overall, because failures can leave long scars. Another commenter felt it was difficult to justify investment on a cost basis for condensing water heating. According to a Rinnai tradesman trainer, the lower cost for venting a condensing unit cancels the higher cost of the condensing heater. Another commenter questioned whether BSC's general stance on the importance of sealed combustion was a real driver yet in the United States, or whether forced draft was adequate.

Combination systems may make the most economic sense in new construction, because there will be only one gas line and vent pipe, there will be no old scaled pipes involved to cause flow or inlet filter clogging problems, and proper design of the total system is possible (including properly sized and insulated plumbing to avoid extended delay time in delivering water). In retrofit cases, the existing gas service line (either the outside utility line or in building) may not have adequate capacity to serve the high demand of a TWH or high capacity SWH.

## 4 Summary of Gaps and Barriers

Discussions occurred during and after each of the seven presentations. A summary of the gaps and barriers discussed is given here in the context of the last key question established before the meeting.

### 4.1 What new testing, field studies, and standards work are needed to fill important knowledge gaps or barriers that could impede efficient and reliable combination system applications?

New factory-supplied total systems are needed to overcome mixed supplier conflicts. Improved design and control methodologies are needed to maximize combination system benefits. This includes predicting and achieving better consumer comfort and energy savings. For example, by providing stable water temperature throughout the range of common flow rates and use patterns, ensuring consistent condensing operation, fully understanding the pros and cons of adding small storage volumes to combination systems using TWHs, and adding solar preheat to combination systems.

Building America supported field and laboratory testing is needed to help move that evolution along faster. Building America prototype and community homes are ideal for combination system applications, because the heating loads are low and the homes maintain temperature for a long time, allowing DHW priority control schemes to work well and be unnoticed by the occupants. The savings in equipment cost can be applied to other energy efficiency improvements, or just make the house or retrofit project more affordable.

To optimize and monitor efficiency and comfort of combination systems, a comprehensive control strategy needs to be developed and tested to coordinate the control of the heating circulator flow, air handler flow, and TWH heating output. Control parameters would be the heating water return temperature (to optimize water heating condensing efficiency), heating SAT (to optimize space heating efficiency and comfort), and DHW supply temperature after the mixing valve (to optimize comfort and safety). This would require a variable-speed space heating circulator and fan, modulating or staged gas valve components, and multiple temperature and flow sensors.

There are really no standards or peer-reviewed guides for efficient combination system design. Most systems are designed and installed by trial-and-error “experts” from smaller independent heating system companies.

In North America two test methods are available for evaluating the performance of combination systems. American Society of Heating, Refrigerating and Air-Conditioning Engineers Standard 124 – 2007, “Methods of Testing for Rating Combination Space-Heating and Water-Heating Appliances,” covers gas, oil, and electricity for forced air and hydronic systems, yielding a combined annual efficiency. Canadian Standards Association Standard P.9–2011 is under development and covers gas and oil, for forced air only, yielding a thermal performance factor, a composite space heating efficiency, a water heating performance factor, and a 1-h water delivery rating.



The American Society of Heating, Refrigerating and Air-Conditioning Engineers Standard 124 is deficient in a number of ways. For example, it allows for testing the components individually, but not as a complete operating system, so the real combined performance cannot be assessed. Manufacturer controls that may enhance the equipment performance have to be disabled for testing. The test method also requires prescribed temperatures and factors that may not provide a realistic rating for actual use conditions.

The Canadian Standards Association Standard P.9-2011 is being developed to improve on those deficiencies by allowing for customized temperature set points and controls to test the system at the conditions in which it operates. It also calls for testing at two weighted part-load conditions (15% and 40%), as well as at the maximum input rate in heating mode.

The rating performance standards for combination systems need to be expanded and improved to encompass the new equipment and designs on approaching the market. That is also needed to better predict actual performance by testing and modeling more realistic use patterns and a wider range of inlet and outlet water temperatures, including for solar preheat to combination systems.

Manufacturers see benefits in Building America developing third-party programs to determine the benefits and application differences between the various technologies, such as the impact on water use, electricity and gas consumption and demand, and consumer behavior, then providing industry with guidance on best practices.

## 5 Next Steps

Data should continue to be sought to learn more about actual hot water use profiles for combination systems and the response and efficiency of different configurations used to meet those demands. BSC will continue to monitor two combination systems in New York and expects to add another site in Pennsylvania soon. By building on past experience, the collected monitoring data, and the information generated by this expert meeting, BSC will draft a Measure Guideline for implementing combination space and DHW systems in 2011. It is expected that this document will continue to be updated and improved as more is learned.

Sharing the knowledge and data we have gained with those involved in Standards activities (test methods and performance rating) will produce better information that can be used for predicting the performance of installed combination systems, leading to better designs and further savings. As always, public standards should be developed with as much technical accuracy as possible without stifling private innovation. Continued collaboration with industry partners should include sharing field data and operational observations, helping them focus their creative investments for the best good.

## **Appendix A: Meeting Agenda**



**Agenda for  
Building America Expert Meeting  
on**

***Recommendations For Applying Water Heaters In Combination Space  
And Domestic Water Heating Systems***

Date/Time: Sunday, July 31, 2011  
9 am to 3:30 pm  
Location: Westford Regency Hotel  
219 Littleton Road Westford, MA 01886  
P: 800.543.780, 978.692.8200  
Meeting Manager: Armin Rudd, Building Science Corp., P: 717.867.0123

List of Presenters:

- Hugh Magande (Rinnai USA)  
***The Anatomy of Combination Water and Space Heating Systems***
- Dave Hammond (A.O. Smith)  
***Balancing Performance with Customer Expectations***
- David Corbin (Bosch Thermotechnology)  
***Combination Space Heating Systems - Addressing the Key Questions From a Manufacturers' Perspective***
- Ben Schoenbauer (MN Center for Energy and Environment)  
***Installing Combination Systems: Optimized Designs and Potential Performance Problems***
- Martin Thomas (Natural Resources Canada)  
***Progress On Improved Test and Rating Standards for Combination Space and Domestic Water Heating Systems***
- Larry Weingarten  
***The Science of Water Heating From a Plumber's Perspective***
- Armin Rudd (BSC)  
***Preliminary Field Testing of Combi Systems Using a Tankless Water Heater, With and Without a Small Storage Tank***

The objective of this session is to explore the development needs and commercial possibilities for wide-scale implementation of improved combination space and domestic water heating systems for high performance buildings. As enclosure improvements continue to drive heating loads down, using the same water heating equipment for both space heating and domestic water heating (combi systems) becomes very attractive. However, fully understanding this topic is important to verify energy savings (and their

persistence) toward the Building America energy savings goals of 50% by 2014 to 2017. Discussions on this topic will be applicable to single- and multi-family residential buildings, both new and retrofitted. Systems of particular interest will include those that use sealed combustion, direct vent tankless heaters, condensing or non-condensing, and with or without a buffer/manifold tank. Efficiency, performance, cost, and long-term operating and maintenance issues will be examined.

Key questions regarding this meeting:

1. What are the current industry understandings and experiences relative to the use of combination space and domestic water heating systems in general, and in specific related to the use of tankless water heaters?
2. How does cycling frequency and short-cycling affect the efficiency and life of tankless water heaters?
3. How important are hot water delivery problems associated with hot/cold plug flow (cold water sandwich) and trickle flow?
4. How much does the addition of a small, insulated, storage tank (that acts as a multiport manifold and a buffer against hot water delivery problems) affect overall efficiency, cost, and maintenance?
5. In order to maximize condensing operation, heating coil water supply temperature should be as low as possible, but what are the limits of that to provide comfortable air delivery? What are the related issues and recommendations related to hydronic coil sizing and increased air handler and circulator runtime?
6. What are the issues and effective solutions related to mineral scale in piping and heat exchangers, and clogging of inlet strainers, requiring maintenance?
7. What are the economic advantages and disadvantages of combi systems versus traditional furnace and water heater designs or versus traditional boiler and indirect water heater designs?
8. What new testing, field studies and standards work is needed to fill important knowledge gaps or barriers that could impede efficient and reliable combi system applications?

Expected Results:

As a result of this meeting, a summary report will be prepared and peer-reviewed before final submission and web posting. It is expected that the information obtained, relative to the Key Questions listed above, will lend itself toward the eventual production of a guide for the best practice

application of combination space and domestic water heating systems for new and retrofit residential construction.

Invitees:

Participants will be key people working in the fields of: water heating, space heating, new and retrofit residential construction, and building energy efficiency. A blend of industry, research, and government participants will be sought.

Meeting Agenda:

- 9 am Welcome and Meeting Introduction
- Brief Building America Program Overview
- 9:15 to 12:15 Presentations with Q&A time
  - four 30 minute presentations with 10 min Q&A
  - one 15 minute break
- 12:15 to 1:00 Lunch break (lunches provided)
- 1:00 to 2:30 Presentation with Q&A
  - three 20 minute presentations with 10 min Q&A
- Group discussion to cover key questions
- Wrap up, action items, and follow-up plan
- 3:30 pm Adjourn meeting

## Presenter Bios

### **Hugh Magande**

Hugh Magande is currently Senior Project Engineer and R&D lead at Rinnai Corporation. He is a member of supervisory staff with full responsibility for strategic planning and leadership of all engineering functions and is currently spearheading Rinnai's Energy Policy Programs. Hugh serves as the designated contributor to the AHRI-chaired Working Group to address the proposed DOE Test Procedure for Residential Water Heaters. Hugh is the primary author of installation and training manuals for the Rinnai Hydronic Furnace, and co-author of a textbook titled, "Introduction to Thermo-Fluids Systems Design." Mr. Magande previously worked at Carrier Corporation/UTC as a Product Development Engineer, and at Steinharter-Schwarz Associates as an HVACR Designer/Project Coordinator.

### **David Hammond**

David is currently the General Manager for A. O. Smith WPC Canada located in Fergus, Ontario, Canada. This role has the P&L responsibility for Canada and overall management of the manufacturing facilities, operations, sales, marketing and engineering departments for the Canadian market. David has been with A.O. Smith for 8 years. Previous to A.O. Smith, David had previous positions with Reliance Home Comfort, one of Canada's largest rental companies with over 1.2 million rental water heaters in their portfolio. Prior to Reliance Home Comfort, David spent 20 years with Union Gas, an Ontario natural gas utility, primarily with Operation and Technical responsibilities.

With over 30 years of industry experience; from a manufacturer to having water heater asset performance responsibility to meeting customer's performance expectations; David brings a unique perspective to the water heater industry. Southern Ontario has a high market percentage of air handlers in the condo and townhouse market having been introduced and supported through natural gas utility programs since the early 1990's.

### **David Corbin**

David is a product manager for Bosch Thermotechnology managing gas and electric water heating, storage tank, and solar thermal system product lines. He has worked in energy efficient water heating since 2006. During this time he has worked in a product development role on various products including tankless water heaters, condensing boilers, and hydronic air handlers; including applications related design work. David has an MBA from Georgia State University and a B.S. in Chemical Engineering from Rose-Hulman Institute of Technology

### **Ben Schoenbauer**

Ben Schoenbauer is a research engineer at the Center for Energy and Environment in Minneapolis, MN. At CEE, Ben has been conducting energy efficiency research for both commercial and residential buildings for the last 4 years. He has a Master's degree in Mechanical Engineering from the University of Minnesota and a Bachelor's degree in Physics from St. John's University.

**Martin Thomas, MSc. , C.Eng. , P.Eng.**

Martin is a Member of ASHRAE and a Professional Engineer. Martin is the Chair of ASHRAE SPC 124 (Method of Test for Combination Systems) and the Secretary of ASHRAE SPC 118.2 (Method of Test for Residential water Heaters). Martin is a Chartered Engineer in the UK and a Professional Engineer in Ontario, Canada.

Martin has worked for both British Gas R&D and The Canadian Gas Research Institute (CGRI). With 25 years of experience, he now works as a Project Engineer at CanmetENERGY in Ottawa, which is a part of Natural Resources Canada (i.e. the Government of Canada). In his duties, Martin develops, tests, and evaluates new residential/commercial technologies that may lead to reduced fuel consumption and GHG (or other pollutant) emissions. His work focuses on maximizing efficiency, using renewable energy and technology integration. Martin also provides technology support to the Office of Energy Efficiency and contributes to the development of Canadian and US performance Standards relating to a variety to energy-using technologies including combination space / water heating systems.

**Larry Weingarten**

Larry has been involved in hot water and energy related work since 1978. Larry has developed a variety of tools and methods for maintaining water heaters and has co-authored a book on the topic. He has also co-authored articles on hot water, energy, and plumbing, and conducts workshops on these subjects. Near Monterey California, Larry lives in a highly-efficient off-grid solar home he designed and built whose radiantly-heated wall systems and daylighting fenestration techniques represent the state of the art in near-zero energy homes.

**Armin Rudd**

Armin Rudd is a Principal at Building Science Corporation where he joined in 1999. For 12 years prior to that, he worked at the Florida Solar Energy Center, a research institute of the University of Central Florida. Armin has 25 years in the field of buildings research and consulting with a wide range of experience in residential and commercial buildings. His career has been especially focused on space conditioning systems, ventilation, dehumidification, and product development. He has authored many technical publications and articles; he is a regular presenter at national conferences, and has earned 12 U.S. patents.



## Appendix B: Attendant List

**Attendance list Combi system expert meeting in Westford, 7/31/2001**

	<b>Last Name</b>	<b>First Name</b>	<b>Company</b>	<b>email</b>
1	Aldrich	Robb	Steven Winter Associates	<a href="mailto:raldrich@swinter.com">raldrich@swinter.com</a>
2	Austin	Mike	J. Pinnelli Co.	<a href="mailto:mike@pinnelli.com">mike@pinnelli.com</a>
3	Bergey	Daniel	BSC	<a href="mailto:daniel@buildingscience.com">daniel@buildingscience.com</a>
4	Bianchi	Marcus	NREL	<a href="mailto:marcus.bianchi@nrel.gov">marcus.bianchi@nrel.gov</a>
5	Brennan	Terry	Camroden Associates	<a href="mailto:terry@camroden.com">terry@camroden.com</a>
6	Chandler	Michael	Chandler Design-Build	<a href="mailto:michael@chandlerdesignbuild.com">michael@chandlerdesignbuild.com</a>
7	Chitwood	Rick	Chitwood Energy	<a href="mailto:rick@chitwoodenergy.com">rick@chitwoodenergy.com</a>
8	Confrey	John	Bosch Thermotechnology	<a href="mailto:john.confrey@us.bosch.com">john.confrey@us.bosch.com</a>
9	Corbin	David	Bosch Thermotechnology	<a href="mailto:david.corbin@us.bosch.com">david.corbin@us.bosch.com</a>
10	Glanville	Paul	Gas Technology Institute	<a href="mailto:paul.glanville@gastechnology.org">paul.glanville@gastechnology.org</a>
11	McAlpine	Jake	Sustainable Resource Center	<a href="mailto:j.mcalpine@src.org">j.mcalpine@src.org</a>
12	Grisolia	Anthony	IBACOS	<a href="mailto:agrisolia@ibacos.com">agrisolia@ibacos.com</a>
13	Hammond	Dave	A.O. Smith	<a href="mailto:dhammond@hotwater.com">dhammond@hotwater.com</a>
14	Healy	Gavin	Balance Point Home Performance	<a href="mailto:gavin@balancepointhp.com">gavin@balancepointhp.com</a>
15	Holladay	Martin	GBA	<a href="mailto:martin@greenbuildingadvisor.com">martin@greenbuildingadvisor.com</a>
16	Henderson	Hugh	CDH Energy	<a href="mailto:hugh@cdhenergy.com">hugh@cdhenergy.com</a>
17	Huelman	Pat	University of Minnesota	<a href="mailto:phuelman@umn.edu">phuelman@umn.edu</a>
18	Kenney	Gary	Affiliated International Management	<a href="mailto:gary@aim4sustainability.com">gary@aim4sustainability.com</a>
19	Kwak	Ted	Navien America	<a href="mailto:tedk@navienamerica.com">tedk@navienamerica.com</a>
20	Magande	Hugh	Rinnai US	<a href="mailto:hmagande@rinnai.us">hmagande@rinnai.us</a>
21	Marcelino	Ron	Rheem Manufacturing	<a href="mailto:ron.marcelino@rheem.com">ron.marcelino@rheem.com</a>
22	McKenna	Jim	U.S. Boiler Co.	<a href="mailto:jmckenna@usboiler.net">jmckenna@usboiler.net</a>
23	Moore	Ray	J. Pinnelli Co.	<a href="mailto:ray@pinnelli.com">ray@pinnelli.com</a>
24	Oberg	Brad	IBACOS	<a href="mailto:boberg@ibacos.com">boberg@ibacos.com</a>
25	Osser	Roselin	BSC	<a href="mailto:rosie@buildingscience.com">rosie@buildingscience.com</a>
26	Pedrick	Greg	NYSERDA	<a href="mailto:gap@nyserda.org">gap@nyserda.org</a>
27	Perunko	Dan	Balance Point Home Performance	<a href="mailto:balancepoint@hughes.net">balancepoint@hughes.net</a>
28	Prahl	Duncan	IBACOS	<a href="mailto:dprahl@ibacos.com">dprahl@ibacos.com</a>
29	Rogers	Michael	Green Homes America	<a href="mailto:mike.rogers@greenhomesamerica.com">mike.rogers@greenhomesamerica.com</a>
30	Rudd	Armin	BSC	<a href="mailto:arudd@buildingscience.com">arudd@buildingscience.com</a>
31	Schoenbauer	Ben	MN Center for Energy and Environment	<a href="mailto:bschoenbauer@mncee.org">bschoenbauer@mncee.org</a>
32	Thomas	Martin	NRCAN	<a href="mailto:martin.thomas@nrcan.gc.ca">martin.thomas@nrcan.gc.ca</a>
33	Townsend	Brad	Masco Contractor Services	<a href="mailto:brad.townsend@mascocs.com">brad.townsend@mascocs.com</a>
34	Ueno	Kohta	BSC	<a href="mailto:kohta@buildingscience.com">kohta@buildingscience.com</a>
35	Vieira	Rob	FSEC	<a href="mailto:robin@fsec.ucf.edu">robin@fsec.ucf.edu</a>
36	Watson	Richard	SSHC, Inc.	<a href="mailto:rwatson@sshcinc.com">rwatson@sshcinc.com</a>
37	Weingarten	Larry		<a href="mailto:eleent@mbay.net">eleent@mbay.net</a>
38	Werling	Eric	US DOE	<a href="mailto:eric.werling@ee.doe.gov">eric.werling@ee.doe.gov</a>
39	Wigington	Linda	Affordable Comfort	<a href="mailto:lwigington@affordablecomfort.org">lwigington@affordablecomfort.org</a>

## Appendix C: Presentations

**Rinnai**



## Tankless Heating Systems

### The Anatomy of Combination Water and Space Heating Systems

Presenter: Hugh Magande, MSEM, MBA, BEME



**Rinnai**

### Topics of Discussion

- Tankless technology overview
- Tankless Heating System: the general idea
- Temperature Profiles (cold water sandwich issue)
  - No Mixing Valve; No Manifold
  - Mixing Valve; No Manifold
  - No Mixing Valve; w/Manifold
  - w/Mixing Valve and Manifold
- Condensing Technology
  - Factors Influencing Effectiveness of Condensing Technology



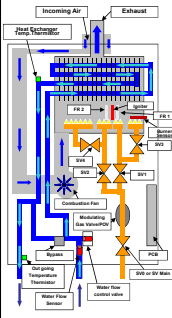

**Rinnai**

### Sequence of Operation (Indoor LS-VB Unit)



- 1. Water flow begins**
  - Water flow sensor sends pulses to the PCB
  - When flow exceeds approximately "0.4 gpm the ignition sequence begins.
  - \*Model dependent
- 2. Ignition Sequence**
  - Combustion fan turns to allow correct air flow thru unit
  - Spark igniter begins sparking and gas control valve opens to low fire rate
  - When flame rods prove ignition spark igniter stops sparking
- 3. Normal Operation**
  - PCB monitors flame rods, fan motor frequency, flame characteristic, outlet water temperature, temperature set point, and water flow rate
  - Gas valve assembly & fan speed modulate gas and air input to meet user demand
  - If demand is very small, only SV1 will allow gas to burner, FR1 will monitor this minimum fire state
  - If demand is large flame can develop across the entire burner
  - Water is heated as it passes thru heat exchanger multiple times
  - Heat exchanger strategically overheats water while the fixed or variable bypass cools to the set point temperature to provide higher flow rates
  - Water flow control valve is adjusted, as needed
- 4. Shut-down Sequence**
  - PCB senses flow rate 0.3 gpm or lower
  - Gas control valve closes & water flow control valve resets to standby position
  - Combustion fan runs for a short period of time at low speed
- 5. Standby Mode**
  - PCB monitors all components. Freeze protection is activated as needed



**Rinnai**

### Groundwater Temperature Map

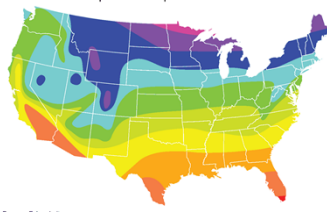

Degrees Fahrenheit:  
 20 25 30 35 40 45 50 55 60 65 70 75

#### U.S. average Ground Water temperatures

**EXAMPLE:**  
 Rinnai Tankless Water Heater's temperature at controller = 120°  
 Subtract the incoming temperature from the water heater's set temperature for  $\Delta T$ :  $120^\circ - 57^\circ = 63^\circ \Delta T$

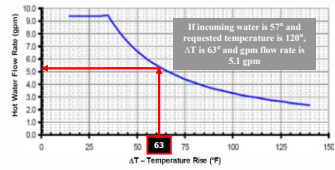

**Rinnai**

If incoming water is 57° and requested temperature is 120°,  $\Delta T$  is 63° and gpm flow rate is 5.1 gpm

#### Understanding Maximum Flow Rate (R94 Lse Flow Curve)

The tankless water heater's first priority is to provide the set point temperature to the user. Based on the  $\Delta T$ , the tankless product may regulate flow to ensure it can provide the selected temperature.



**Rinnai**

### Maximum Flow Rate by Model

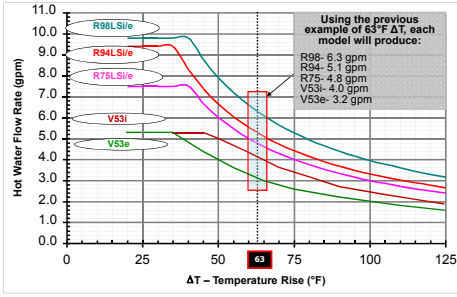

Using the previous example of 63°F  $\Delta T$ , each model will produce:

- R98- 6.3 gpm
- R94- 5.1 gpm
- R75- 4.8 gpm
- V53i- 4.0 gpm
- V53e- 3.2 gpm



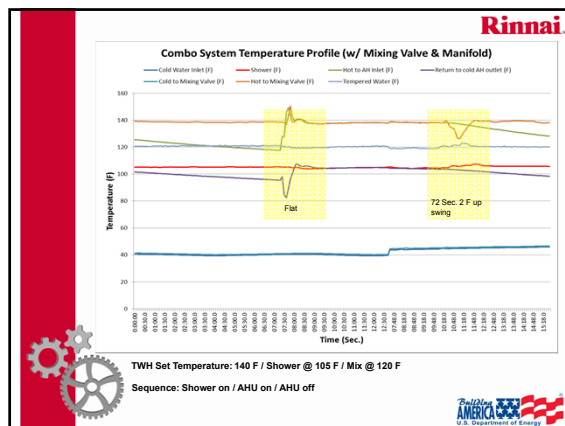
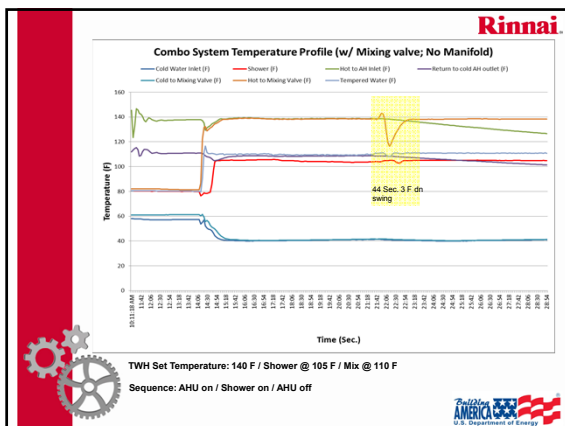
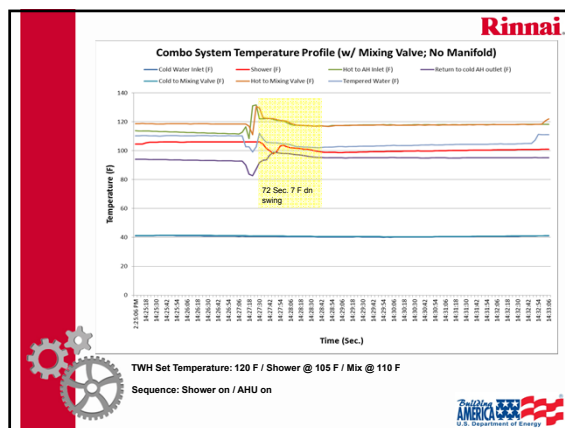
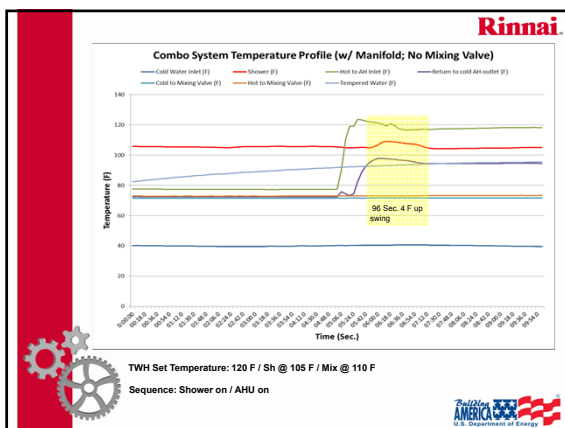
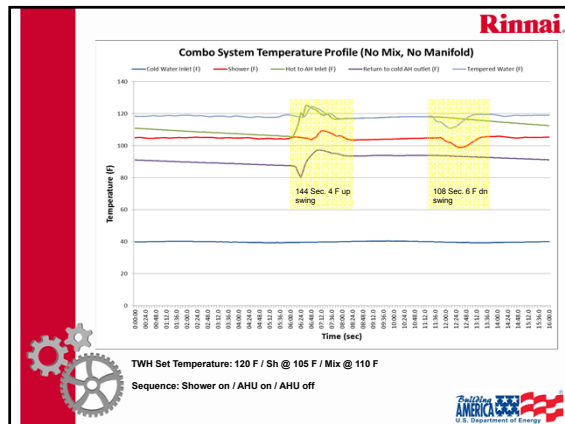
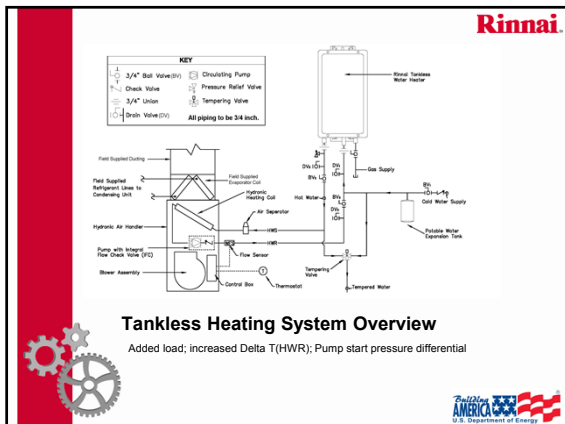

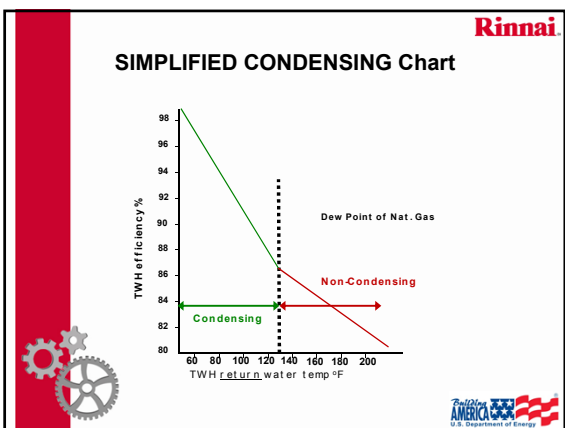
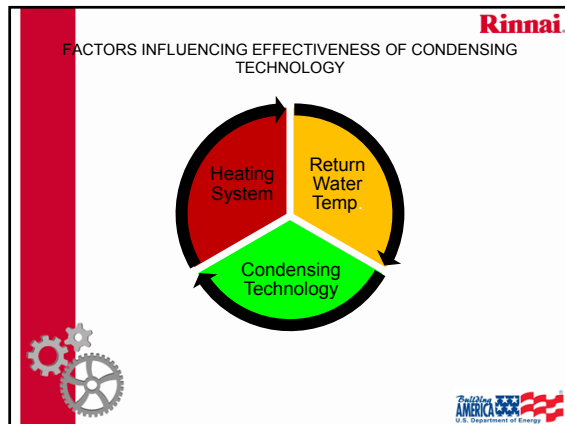
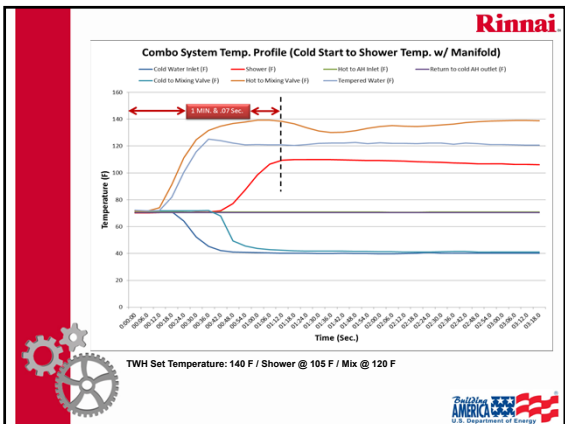

Questions?  
 Questions?  
 Questions?  
 Questions?



### Applying Water Heaters In Combination Space and Domestic Water Heating Systems

July 31, 2011



### Balancing Performance with Customer Expectations

### North American Climate Zones

- While the heating and cooling requirements vary across North America; everyone uses some type of hot water heater.

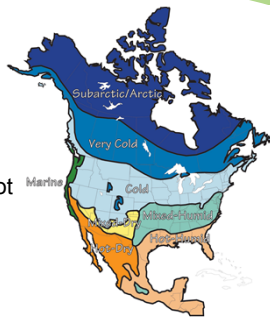

July 31, 2011

Image from www.buildingscience.com

### Multiple Sources of Hot Water

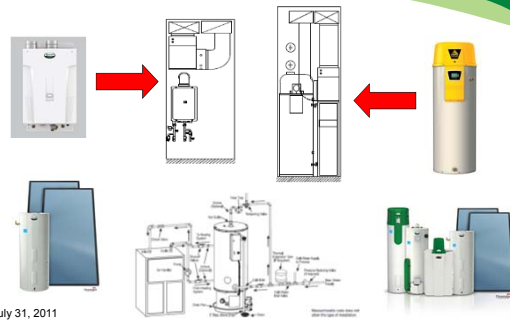

July 31, 2011

### History: Initial Market - Townhouse and condo

- Capital cost reduction
- Squeeze into mechanical closets to gain more living space
- Created installation issues such as ventilation air, venting and piping
- Experience led to better designed mechanical closets



July 31, 2011

### Integrated Field Installations

- Customer issue: reduced performance at draws of over 3 gpm
- After correcting some installation faults (eg increase to 3/4 piping, faster acting thermostat)
- Conducted multiple draw schedules.
- Use of small storage tank (20, 30, 40 USG) to measure increased flow.

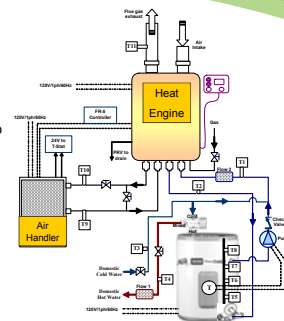

July 31, 2011

## Addition of Small Storage Tank

- Affect overall efficiency, cost and maintenance
  - Cost of pump
  - Standby loss from piping
  - Unintended positive consequence: Freeze protection in harsh climate
- Storage tank design
  - Design modifications from standard storage tank to maximize performance.



July 31, 2011

## Innovation and Design Applications

- Industry has and will continue to provide the spark to develop products that will solve many of the issues.
  - New factory supplied systems that overcome mixed supplier conflict
  - Design and controls methodology to maximize benefits (Consumer comfort, energy savings)
- Allow field design and creativity to overcome unique applications.



July 31, 2011

## Saving Money or Saving Energy

- Builder may side on lowest capital cost while the consumer (if educated) should prefer the lowest total life cycle costs
- Best way to save energy is to avoid the need in the first place.
- Furnace and Water Heater is the norm; need to educate on other options



July 31, 2011



## Design Considerations

## Cycling Frequency and Short Cycling

- Regardless of product (heat engine or air handler); short cycling can lead to customer issues and premature failure of component parts.
- Pre-purge and post purge impact
- Run time to reach condensing mode
- Controls strategy is required to avoid cycling

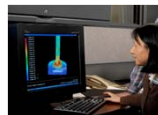

July 31, 2011

## Condensing Considerations

- Balancing for Max Condensing requires controlling the air flow temperature
  - Cool air
    - Control speed of air flow, use variable speed fans, ensure grill locations are appropriate
    - Advanced duct design
- Air Handlers can run off geothermal systems at 105F, so design is critical
  - Larger coils, however there is an economic tradeoff,
  - Pump flow controls to manage return water temperature control.

July 31, 2011



## System Comparison

	Capital Cost	Energy Use	Total Life Cycle Costs
Condensing Furnace and Water Heater	\$\$\$\$	Energy usage could be equivalent based on design and application.	Need validated total life cycle costs.
Air Handler + Condensing Storage Type Water Heater	\$\$\$		
Air Handler + Condensing Tankless	\$\$\$		
Condensing Boiler + Air Handler	\$\$\$\$\$		
Solar Pre Heat + Air Handler	\$\$\$\$\$		
			Utility studies underway.

July 31, 2011

## What work is needed to fill gaps and barriers

- Develop 3<sup>rd</sup> party programs to determine the benefits and application differences btwn various technologies
  - Impact on water usage
  - Electrical consumption
  - Consumer behaviour
- Training, then some more training at each level of the supply chain
- Provide industry guidance on best practices

July 31, 2011

## Future

- From manufacturer's view - volume is key
- Marketing ... entrenched furnace and water heater culture.
  - Need to define the benefits of the integrated system
- Need to make the systems less complex at the field level.
- Control strategies to maximize comfort and energy savings.



July 31, 2011

## Closing Thoughts

- Multiple condensing heat engine products will compete in the market.
- Each will need to find the right application for that technology
- Consideration for total life cycle costs
- Design and control strategy can overcome most performance issue
- Let innovation drive product development.

July 31, 2011

## Questions

HIGH EFFICIENCY  
IN EVERY CATEGORY



July 31, 2011

July 31st, 2011  
Tankless and Space Heating



Londonderry – January 6<sup>th</sup>, 2010  
**Combination Space Heating - Addressing the Key Questions From a Manufacturers' Perspective**

Thermotechnology  
07.31.2011 © Bosch Thermotechnology 2010. All rights reserved, also regarding any disposal, exploitation, reproduction, editing, distribution, as well as in the event of applications for industrial property rights.

**BOSCH**

July 31st, 2011  
Tankless and Space Heating

**Agenda**

- Current Experiences
  - Who?
  - What?
- Tankless as a Heat Source
  - Cycle Frequency and Short Cycling
  - Hot Water Delivery Issues
  - Using Storage as a Manifold
  - Scale and System Debris
- Combi-System or Traditional?
- Future Knowledge

Thermotechnology  
07.31.2011 © Bosch Thermotechnology 2010. All rights reserved, also regarding any disposal, exploitation, reproduction, editing, distribution, as well as in the event of applications for industrial property rights.

**BOSCH**

July 31st, 2011  
Tankless and Space Heating

**Current Experiences**

- Who is installing open loop combination systems?
  - Smaller independent heating system companies
    - "Experts" from trial and error system design
  - Some larger plumbing companies
  - Experienced D-I-Y installers
    - Homeowners looking for a "cheaper" boiler



Thermotechnology  
07.31.2011 © Bosch Thermotechnology 2010. All rights reserved, also regarding any disposal, exploitation, reproduction, editing, distribution, as well as in the event of applications for industrial property rights.

**BOSCH**

July 31st, 2011  
Tankless and Space Heating

**Current Experiences**

- What types of systems are they installing?
  - Open Loop
    - Separated
    - Non-separated
  - Closed Loop
    - Water heaters used in boiler applications
    - Un-certified or questionable installations

Thermotechnology  
07.31.2011 © Bosch Thermotechnology 2010. All rights reserved, also regarding any disposal, exploitation, reproduction, editing, distribution, as well as in the event of applications for industrial property rights.

**BOSCH**

July 31st, 2011  
Tankless and Space Heating

**Open Loop**

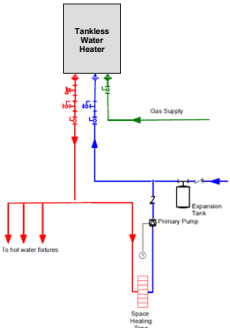

Thermotechnology  
07.31.2011 © Bosch Thermotechnology 2010. All rights reserved, also regarding any disposal, exploitation, reproduction, editing, distribution, as well as in the event of applications for industrial property rights.

**BOSCH**

July 31st, 2011  
Tankless and Space Heating

**Open Loop - Separated**

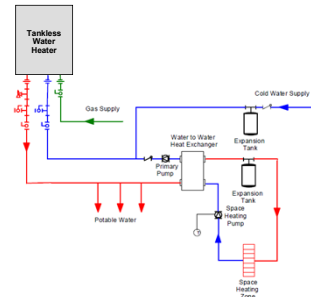

Thermotechnology  
07.31.2011 © Bosch Thermotechnology 2010. All rights reserved, also regarding any disposal, exploitation, reproduction, editing, distribution, as well as in the event of applications for industrial property rights.

**BOSCH**

July 31st, 2011  
Tankless and Space Heating

### Closed Loop – Boiler Application

Thermotechnology  
07.31.2011 © Bosch Thermotechnology 2010. All rights reserved, also regarding any disposal, exploitation, reproduction, editing, distribution, as well as in the event of applications for industrial property rights.

**BOSCH**

July 31st, 2011  
Tankless and Space Heating

### Current Experiences – Issues and Concerns

- Health
  - System stagnation
  - Use of non-potable system components
- Safety
  - Failure to use scald prevention devices in high temperature application
- Efficiency
  - Lack of condensing at high temperatures
  - No standards for efficient system design

Thermotechnology  
07.31.2011 © Bosch Thermotechnology 2010. All rights reserved, also regarding any disposal, exploitation, reproduction, editing, distribution, as well as in the event of applications for industrial property rights.

**BOSCH**

July 31st, 2011  
Tankless and Space Heating

### Tankless as a Heat Source

- Radiant Floor (98F – 120F)
  - Low temperature
  - Longer run times
  - Simple Controls
    - DHW priority is unnecessary
- Air Handler
  - Mid to High temperature (140F+)
  - Shorter cyclical run times (< 10 minutes)
  - Complex Controls
    - Lack of DHW can cause "cold blow"

Thermotechnology  
07.31.2011 © Bosch Thermotechnology 2010. All rights reserved, also regarding any disposal, exploitation, reproduction, editing, distribution, as well as in the event of applications for industrial property rights.

**BOSCH**

July 31st, 2011  
Tankless and Space Heating

### Tankless as a Heat Source

- Baseboard
  - Typically high temperatures (160+)
  - Lower temperature systems exist
- Cast iron radiators corrode and can clog filters or components
  - Copper radiators common in newer systems
- Longer run times

Thermotechnology  
07.31.2011 © Bosch Thermotechnology 2010. All rights reserved, also regarding any disposal, exploitation, reproduction, editing, distribution, as well as in the event of applications for industrial property rights.

**BOSCH**

July 31st, 2011  
Tankless and Space Heating

### Tankless as a Heat Source – Short Cycling

- Definition of short cycling
  - Run time less than 10 seconds
- Potential effects on tankless
  - Wear and Tear
  - Is usable energy delivered?
- Short Cycling is not usually found in space heating applications
  - Exceptions
    - Heat load << minimum firing rate of the appliance
    - Equipment malfunction
    - Improperly sized pumps

Thermotechnology  
07.31.2011 © Bosch Thermotechnology 2010. All rights reserved, also regarding any disposal, exploitation, reproduction, editing, distribution, as well as in the event of applications for industrial property rights.

**BOSCH**

July 31st, 2011  
Tankless and Space Heating

### Tankless as a Heat Source - DHW Delivery Issues

- Additional plumbing related to heating system
  - Benefit
    - Hot/Cold plug flow has more time to dissipate
  - Downside
    - DHW delivery time is increased in non heating times
  - Trickle flow
    - Trickle flow is possible during heating cycles

Thermotechnology  
07.31.2011 © Bosch Thermotechnology 2010. All rights reserved, also regarding any disposal, exploitation, reproduction, editing, distribution, as well as in the event of applications for industrial property rights.

**BOSCH**

July 31st, 2011  
Tankless and Space Heating

### Tankless as a Heat Source – Storage/Manifold

- Un-powered tank
  - Could be designed similar to low loss header
  - Increases DHW delivery time (non heating cycles)
  - Decreases temperature fluctuations
  - Increases energy utilization slightly
    - During heating and DHW cycles
- Powered tank
  - Decreases DHW delivery time
  - Decreases temperature fluctuations
  - Allows Trickle flow always
  - Increases energy utilization slightly
    - During off-cycles and trickle flow

13 Thermotechnology  
07.31.2011 © Bosch Thermotechnology 2010. All rights reserved, also regarding any disposal, exploitation, reproduction, editing, distribution, as well as in the event of applications for industrial property rights.

July 31st, 2011  
Tankless and Space Heating

### Tankless as a Heat Source – Scale and Debris

- Scale
  - Combi systems pose very little additional concern regarding scale when compared to a DHW system
- Debris (Sediment, thread tape, and sealant)
  - Small inlet filter can clog and decrease flow
  - Filter can be removed once thread tape and sealant leave the system
  - Y Strainer is another alternative to prevent clogging

14 Thermotechnology  
07.31.2011 © Bosch Thermotechnology 2010. All rights reserved, also regarding any disposal, exploitation, reproduction, editing, distribution, as well as in the event of applications for industrial property rights.

July 31st, 2011  
Tankless and Space Heating

### Combi System or Traditional?

- New Construction
  - Combi system can reduce overall cost of installation
    - Only one gas line to run
    - Smaller utility room
  - Opportunity for properly designed hydronic system
- Retrofit
  - Must analyze ROI vs. installed costs
  - Existing system may not be suitable for tankless

15 Thermotechnology  
07.31.2011 © Bosch Thermotechnology 2010. All rights reserved, also regarding any disposal, exploitation, reproduction, editing, distribution, as well as in the event of applications for industrial property rights.

July 31st, 2011  
Tankless and Space Heating

System Efficiency and Applicability		Condensing Tankless		Condensing Combi-Boiler		Cond. Boiler + Indirect	
		Rating	Overall	Rating	Overall	Rating	Overall
Radiant Floor	Heating System efficiency	●	●●●	●	●●●	●	●
	Heating System Complexity	●	●●●	●	●●●	●	●
	Domestic Water	●	●	●	●	●	●
Air Handler	Heating System efficiency	●	●	●	●	●	●
	Heating System Complexity	●	●	●	●	●	●
	Domestic Water	●	●	●	●	●	●
Base Board	Heating System efficiency	●	●	●	●	●	●
	Heating System Complexity	●	●	●	●	●	●
	Domestic Water	●	●	●	●	●	●

16 Thermotechnology  
07.31.2011 © Bosch Thermotechnology 2010. All rights reserved, also regarding any disposal, exploitation, reproduction, editing, distribution, as well as in the event of applications for industrial property rights.

July 31st, 2011  
Tankless and Space Heating

System Efficiency and Applicability		Condensing Tankless		Condensing Combi-Boiler		Cond. Boiler + Indirect	
		Rating	Overall	Rating	Overall	Rating	Overall
Radiant Floor	Heating System efficiency	●	●●●	●	●●●	●	●
	Heating System Complexity	●	●●●	●	●●●	●	●
	Domestic Water	●	●	●	●	●	●
Air Handler	Heating System efficiency	●	●	●	●	●	●
	Heating System Complexity	●	●	●	●	●	●
	Domestic Water	●	●	●	●	●	●
Base Board	Heating System efficiency	●	●	●	●	●	●
	Heating System Complexity	●	●	●	●	●	●
	Domestic Water	●	●	●	●	●	●

17 Thermotechnology  
07.31.2011 © Bosch Thermotechnology 2010. All rights reserved, also regarding any disposal, exploitation, reproduction, editing, distribution, as well as in the event of applications for industrial property rights.

July 31st, 2011  
Tankless and Space Heating

System Efficiency and Applicability		Condensing Tankless		Condensing Combi-Boiler		Cond. Boiler + Indirect	
		Rating	Overall	Rating	Overall	Rating	Overall
Radiant Floor	Heating System efficiency	●	●●●	●	●●●	●	●
	Heating System Complexity	●	●●●	●	●●●	●	●
	Domestic Water	●	●	●	●	●	●
Air Handler	Heating System efficiency	●	●	●	●	●	●
	Heating System Complexity	●	●	●	●	●	●
	Domestic Water	●	●	●	●	●	●
Base Board	Heating System efficiency	●	●	●	●	●	●
	Heating System Complexity	●	●	●	●	●	●
	Domestic Water	●	●	●	●	●	●

18 Thermotechnology  
07.31.2011 © Bosch Thermotechnology 2010. All rights reserved, also regarding any disposal, exploitation, reproduction, editing, distribution, as well as in the event of applications for industrial property rights.

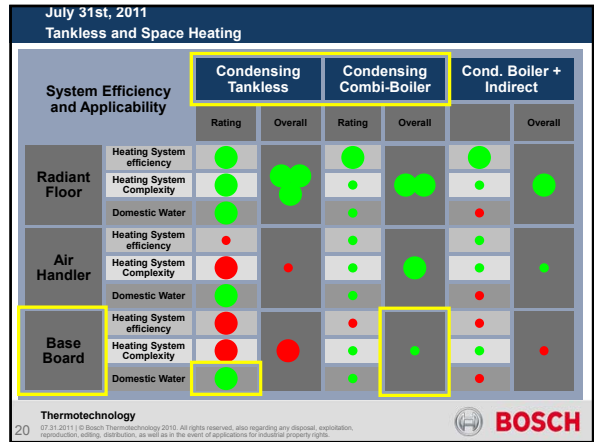
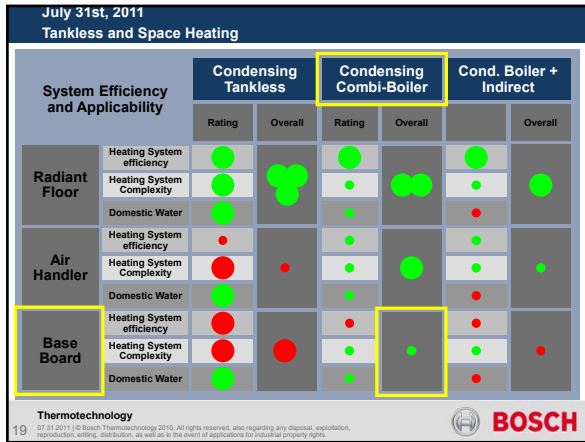

July 31st, 2011  
Tankless and Space Heating

### Issues for the Future

→ Gaps

- Actual system efficiencies when using alternative heat sources
  - Hybrid Water Heaters
  - True effect of small volumes of stored water
- Effect of water pre-heat systems on total system efficiency
  - Solar, Heat Pump, etc.
- Control Systems for non-boiler heat sources

Thermotechnology  
07.31.2011 © Bosch Thermotechnology 2010. All rights reserved, also regarding any disposal, exploitation, reproduction, editing, distribution, as well as in the event of applications for industrial property rights.

21 

July 31st, 2011  
Tankless and Space Heating

Questions?

Thermotechnology  
07.31.2011 © Bosch Thermotechnology 2010. All rights reserved, also regarding any disposal, exploitation, reproduction, editing, distribution, as well as in the event of applications for industrial property rights.

22 

## Installing Combination Systems: Optimized Designs and Potential Performance Problems

Ben Schoenbauer  
Center for Energy and Environment  
Minneapolis, MN



### Project Funding:

- Sustainable Resource Center, Minneapolis, MN
  - DOE SERC Grant
- Building America – NorthernSTAR Team



### How We Got Here

- Sustainable Resource Center
  - Federally funded weatherization
    - Low-income housing, single & multi-family
    - Energy retrofits must pay for themselves in energy savings over their lifetime.
    - \$6500/home average
    - 2-3 hour Audit & diagnosis, mechanical retrofit, air sealing & insulation inc. H&S, inspection
    - ASHRAE 62.2, tightness limits, pressure diag.
  - Combustion Safety PROBLEM
    - Many retrofits with 95% 2 stage ECM furnace ~\$3500 + 65% power vented DWH ~\$1500 – for H&S, less than 10% better



### Federal Innovation Grant

- Sustainable Energy Resources for Consumers Grant.
- Innovation grant from stimulus funding
- No SIR requirements
- Evaluation of actual energy savings
- Recognizes higher cost of new technologies
- Already awarded to 5 agencies in MN
- Pays for installation in over 400 homes state-wide
- 13 month duration, starting now



### Project Overview

- 400+ residential installations by March 2012
  - Needed to scale up fast
- Many contractors had very little experience and were installing appliance out of the box
- Added an initial phase of “Lab” installations
  - To determine best practices for existing equipment installations
  - To demonstrate systems to contractors, codes people, utilities, etc



### Lab Testing

<http://srcefficiencylab.tumblr.com/>



## Equipment

- 4 Boilers
  - Two low mass boilers
  - Two boilers with integral DHW tanks (6, 12 gallons)
- 2 condensing tankless water heaters
  - One with 2 gallons of storage
- 3 condensing tanks
  - 100 btu/hr input with 34, 50, and 50 gallon storage
  - One with modulating burner
- 6 hydronic air handlers
  - Two with built in ventilation

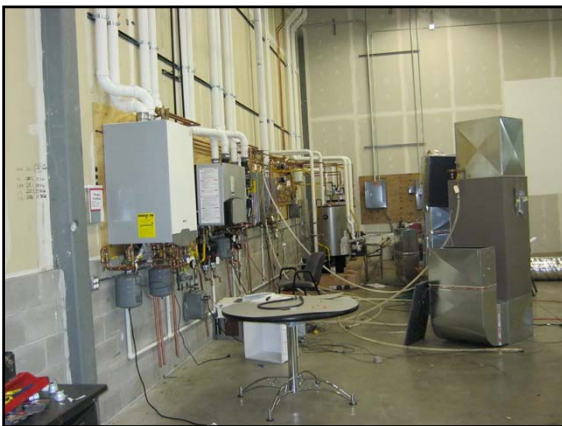

## Lab Testing - Protocol

- Heating Plant Testing
  - Idle tests
  - Simulated air handler return
- Air Handler Testing
  - Output capacity over a range of flow rates and temps
- Full System Tests – Performance Tests
  - Max capacity testing
  - Cyclical testing

## Idle Testing

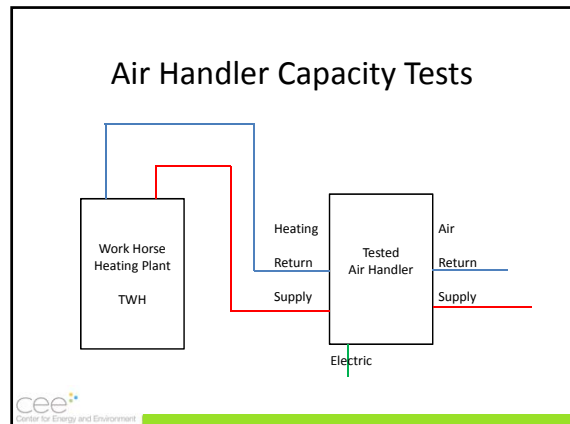
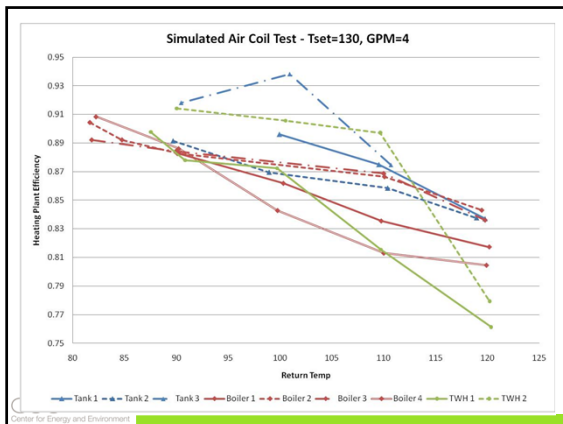
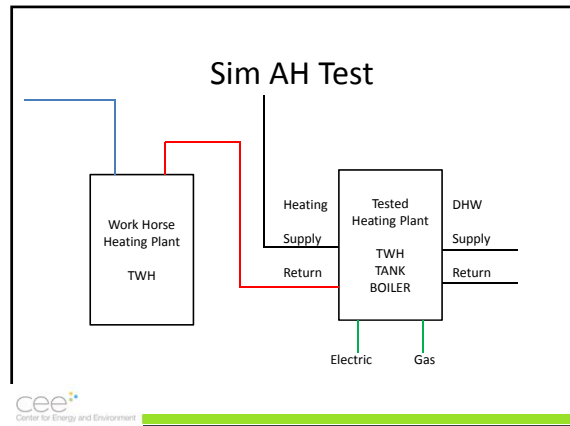
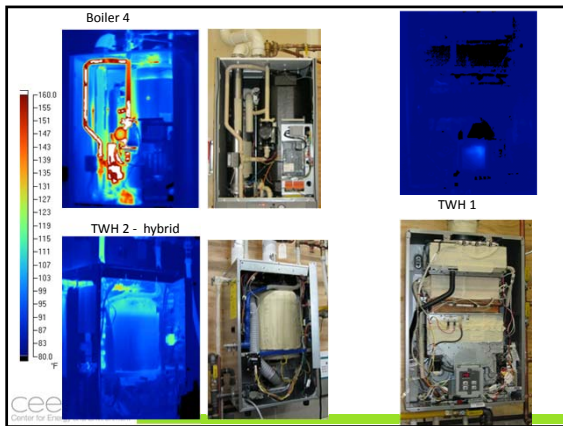
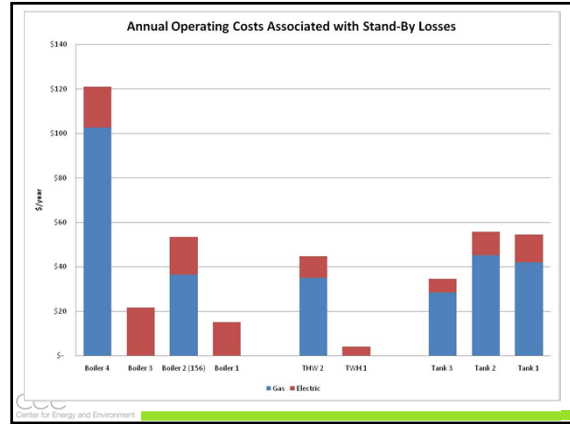
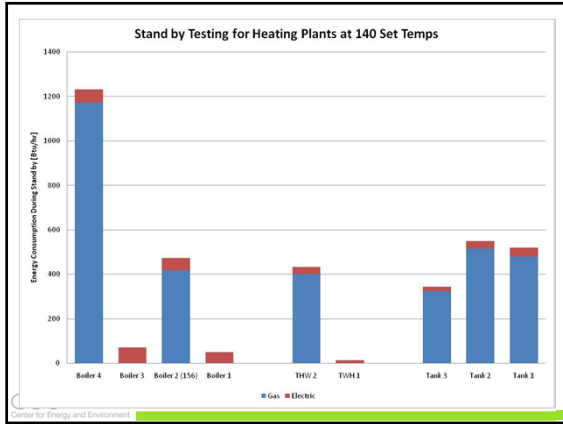



### Air Handler Tests

- Check the performance of the air handlers in the lab versus the specification sheets provided by manufacturers
- Determine for each AH the heating load it can meet at desired air and water temperatures

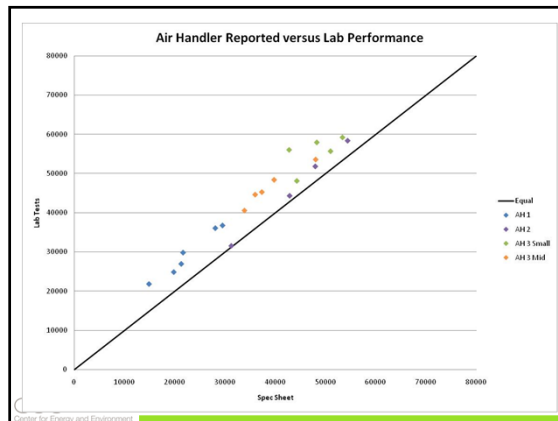

### AH 3 Results

GPM	CFM	T_wt_spl	T_wt_rtn	T_air_sply	Qout
1.5	800	120	88	93	23857
1.5	800	140	85	99	34073
1.5	800	160	105	114	40796
1.5	950	120	86	90	25076
1.5	950	140	94	99	34073
1.5	950	160	102	108	43000
1.5	1150	120	85	88	26305
1.5	1150	140	92	94	35771
1.5	1150	160	99	102	45167
2.5	800	120	87	90	28200
2.5	800	140	89	95	38182
2.5	800	160	121	123	48200
2.5	950	120	84	91	30561
2.5	950	140	107	109	40828
2.5	950	160	118	117	51642
2.5	1150	120	84	91	31347
2.5	1150	140	105	101	43418
2.5	1150	160	116	110	54796
5	800	120	100	101	31646
5	800	140	100	114	40000
5	800	160	134	139	50004
5	950	120	106	99	34617
5	950	140	121	112	44748
5	950	160	136	125	56998
5	1150	120	109	99	37999
5	1150	140	114	106	47991
5	1150	160	134	119	61917
7	800	120	110	104	31004
7	800	140	110	117	40000
7	800	160	144	131	56248
7	950	120	110	101	33802
7	950	140	126	114	45000
7	950	160	142	127	61150
7	1150	120	109	97	38700
7	1150	140	117	107	50748
7	1150	160	141	132	68007

GPM	CFM	T_wt_spl	T_wt_rtn	T_air_sply	Qout
1.5	800	120	88	93	23857
1.5	800	140	103	98	31489
1.5	800	160	105	114	40796
1.5	950	120	86	90	25076
1.5	950	140	94	99	34073
1.5	950	160	102	108	43000
1.5	1150	120	85	86	26305
1.5	1150	140	92	94	35771
1.5	1150	160	99	102	45167

AH is rated for 60,000 Btu/hr heating



GPM	CFM	T_wt_spl	T_wt_rtn	T_air_sply	Qout
1.5	800	120			
1.5	800	140			
1.5	800	160	105	114	40796
1.5	950	120			
1.5	950	140	102	108	43000
1.5	1150	120			
1.5	1150	140			
1.5	1150	160			
2.5	800	120			
2.5	800	140			
2.5	800	160			
2.5	950	120			
2.5	950	140	107	108	40828
2.5	950	160			
2.5	1150	120			
2.5	1150	140			
2.5	1150	160			
5	800	120			
5	800	140			
5	800	160			
5	950	120			
5	950	140			
5	950	160			
5	1150	120			
5	1150	140			
5	1150	160			
7	800	120			
7	800	140			
7	800	160			
7	950	120			
7	950	140			
7	950	160			
7	1150	120			
7	1150	140			
7	1150	160			

### AH 3 Results

- Allowing Settings so that
- Return Water T <107
- Supply Air T >105
- Outputs around 40,000Btu/hr
- Options are limited

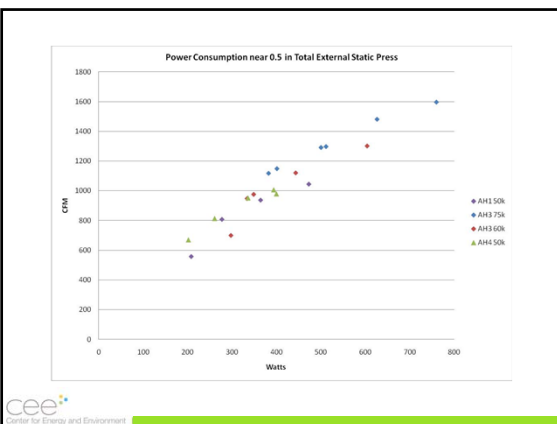

### Full System Demo

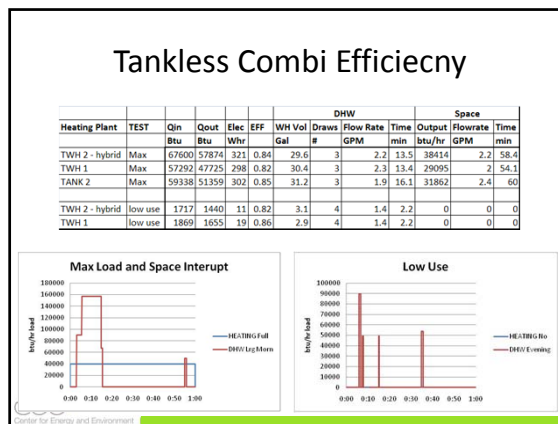
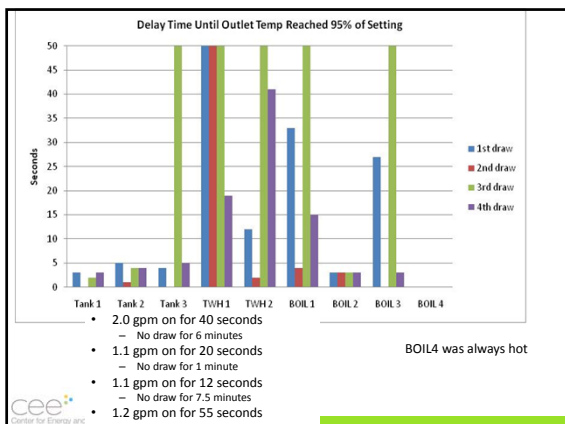
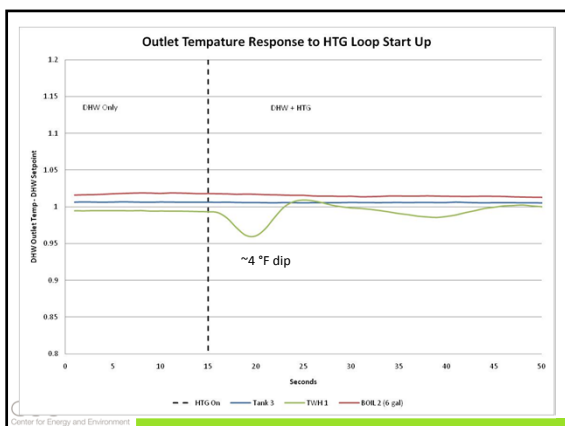
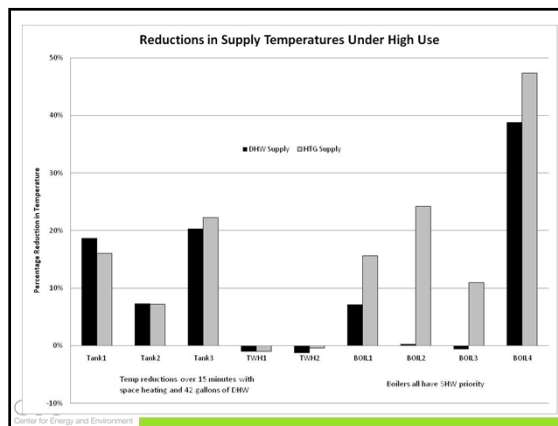
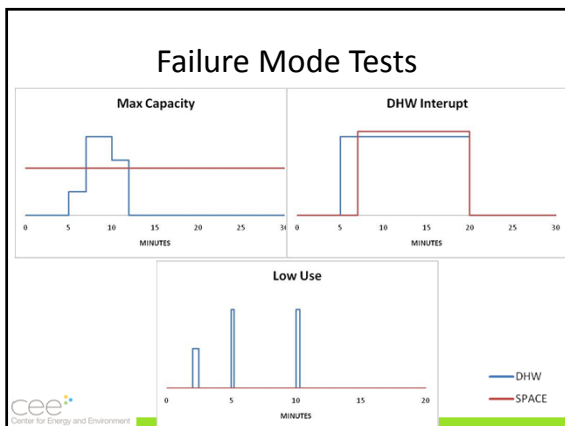

### Upcoming: Field Installations

- 400 installs in Minnesota before March 2012
  - Detailed Pre/Post monitoring on 20 sites
  - Utility Bill analysis on all 400 sites
- System selection based on:
  - Space Heating Load
  - Perceived DHW load (both daily usage and simultaneity)
  - Water hardness
  - Cost



### Field Installations: Systems/Cost

- Data from 8 sites with completed installs and bills submitted

Site #	install cost	Contractor	parts	labor	HP	AH
1	\$6,432	A	\$4,877	\$1,555	TWH 2 Hybrid	AH3 75000
2	\$7,508	A	\$5,953	\$1,555	Tank 2 - 55 gal	AH3 75000
5	\$6,835	A	\$5,280	\$1,555	Tank 2 - 34 gal	AH3 75000
6	\$7,135	A	\$5,500	\$1,635	Tank 2 - 55 gal	AH3 75000
3	\$9,925	B	\$7,500	\$2,425	Tank 3 50 gal	AH3 90000
4	\$8,830	B	\$5,745	\$3,085	TWH 2 Hybrid	AH3 75000
7	\$8,909	B	\$5,397	\$3,512	TWH 2 Hybrid	AH3 60000
8	\$9,453	B	\$7,053	\$2,400	Tank 2 - 55 gal	AH3 75000

Mostly sites with high water hardness which effected product selection. High water hardness will not be a concern for all homes.



### Installation Costs

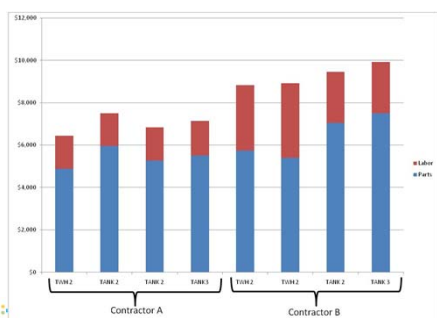

### Issues to Consider

- Multiple speed ECM fluid pumps
- Primary secondary loop configuration for boiler based systems
- Air handlers with fan cut out for DHW prioritization
- Integrated system packages with built in controls



**CanmetENERGY**  
Leadership in ecoinnovation



**Progress On Improved Testing and Rating Standards for Combination Space and Domestic Water Heating**





Prepared By: Martin Thomas & Rosalyn Cochrane,  
Natural Resources Canada

For: Building America Expert Meeting, July 31, 2011

**Definition:**

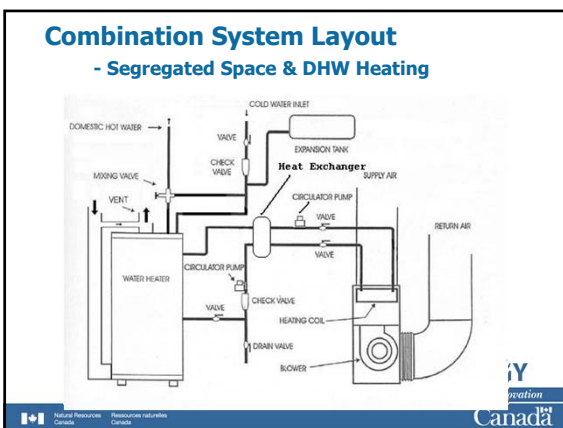

- **Combined space and water heating system (“combo”)** — a product or a group of individual components that form an integrated system that is designed to provide space heating and water heating.
- **Note:** We discourage the use of “Combos” based on non-condensing tank water heaters + fan coils.

**Why Build a Combination System?**

- Integrating the space & water heating functions can lead to synergistic efficiency benefits.
- As space heating loads drop, the water heating load becomes more significant; with EE housing, overall the two loads become comparable
- The combination and flexibility offered with the two loads can allow for the technology to be suitable for low energy or near net-zero housing.
- Venting & gas/fuel connections are simplified resulting in a compact, potentially lower cost, installation.

**CanmetENERGY**  
Leadership in ecoinnovation



**Test Methods Available**

In North America there are two\* test Methods Available:

- ASHRAE 124 – 2007
  - Covers Gas, Oil & Electric, Forced Air & Hydronic.
  - Yields a Combined Annual Efficiency (CAE)
- CSA P.9 – 2011
  - Covers Gas & Oil, Forced Air only.
  - Yields a Thermal Performance Factor (TPF)

\* There is also ASHRAE 206.

**CanmetENERGY**  
Leadership in ecoinnovation







**Differences Between the Two Test Methods**

With ASHRAE 124 :

- there is no way to assess the combined performance, i.e. Testing a combo as an operating system, not individual components.
- Combo may be rated under unrealistic conditions.
- Test does not evaluate the complete system and recognize performance interactions and synergies
  - Smart integration
  - Advanced controls

**CanmetENERGY**  
Leadership in ecoinnovation

### Differences Between the Two Test Methods

With CSA P.9 :

- Doesn't force set points, which allow manufacturers to be creative with controls.
- Tests and rates at the conditions in which the system operates, as opposed to being tested to current test methods that are strictly applicable to that component.
- Two Part load efficiencies in space heating mode (plus maximum input rate).
- Separate combined duty test.

CanmetENERGY  
Leadership in ecoInnovation



### The CSA P.9 in More Detail

System Categories:

- **Type A System:** a combo with a fixed capacity for space heating;
- **Type B System:** a combo equipped with controls that automatically adjust the space heating capacity based on the space heating load; and
- **Type C System:** a combo with a thermal storage tank or equivalent that decouples the space heating load from the burner control.

CanmetENERGY  
Leadership in ecoInnovation



### The CSA P.9 in More Detail

Currently does not apply to:

- Hydronic distribution (Future work for P.9)
- Electric and solar-based combo systems;
- Not test-verified for oil yet.
- solid-fuel-based combo systems; and
- multi-family dwellings with a central heating plant

CanmetENERGY  
Leadership in ecoInnovation



### The CSA P.9 in More Detail

- Overall performance factor needs to aggregate performance in each operating condition
- Consistent set-ups required and equipment functions need to be fully operational during all tests
- Controls need to be operational during performance testing
- Space heating needs to include (weighted) part-load fractions

CanmetENERGY  
Leadership in ecoInnovation



### P.9 Performance Descriptors

- Thermal Performance Factor (TPF)
- Composite Space Heating Efficiency (CSHE)
- Water Heating Performance Factor (WHPF)
- 1 hr Water Delivery Rating (OHR)

CanmetENERGY  
Leadership in ecoInnovation



### Space Heating Performance

- Input-Output air enthalpy approach
- Part load testing and rating based on load-weighted performance measurements
- Part load space heating cyclic tests  
15%, 40% and Full load output,
- $CSHE = 0.1 \times Eff(100\%) + 0.6 \times Eff(40\%) + 0.3 \times Eff(15\%)$
- Takes into account the energy input delivered to the airstream (excludes casing/pipe losses)

CanmetENERGY  
Leadership in ecoInnovation



### Water Heating Performance

- Water enthalpy method (energy out / energy In)
- 24 hr simulated use test and recovery efficiency
- Combo capacity as a water heater determined and reported as a one (first) hour rating
- Additional capacity testing done with and without concurrent calls for space heating (Combined operation)
- Same as CSA P.3, ASHRAE 118.2, or US DOE EF test.



### Overall Performance Rating

Thermal Performance Factor (TPF)

$$TPF = \frac{2000H_{CAP} + 4400}{[2000H_{CAP}/CSHE] + [4400/WHPF]}$$

2000 = an annualized aggregate rating of the number of full-load operating hours of the combo in space heating mode, h

H<sub>CAP</sub> = full-load space heating system output, kW (Btu/h)

4400 = annual domestic hot water draw load based on the standardized water heating simulated use test (SUT), kWh (Btu)

CSHE = composite space heating efficiency

WHPF = water heating performance factor



### The ASHRAE 124 in a Nutshell

- Uses ASHRAE 103 to test Hot Water Generator as a boiler to get Eff<sub>ys</sub> = space-heating seasonal efficiency (%) under fixed test conditions.
- Tests at minimum and maximum heat input.
- Uses ASHRAE 118.2 (or 118.1) to establish water heating efficiency (EF).
- Uses weighting factors based on: the temp. base for HDD = 65° F, US ave. outdoor temp. over heating season = 42° F, US ave. outdoor heating design temp. = 5° F, oversize fraction = 0.7 and the ratio of energy delivered in hot water to the maximum possible energy use per day.



### The ASHRAE 124 in a Nutshell

Combined Annual Efficiency, CAE

$$CAE = \frac{[(SHF \times Eff_{ys}/100) + (WHF \times Eff_{ys}/100) + (R \times NHF \times EF)]}{[(SHF) + (WHF) + (R \times NHF)]}$$

Where:

- SHF = Space Heating Factor
- WHF = Heating Season Water Heating Factor
- NHF = Non-Heating Season Water Heating Factor
- EF = Water Heater Energy Factor
- Eff<sub>ys</sub> = Space-Heating Seasonal Efficiency
- Eff<sub>ss</sub> = Steady State Space-Heating Efficiency
- R = ratio of non-heating-season days to heating-season days



### Technologies tested?

- Combo 1:** Power vented non-condensing storage WH coupled with (48,000 Btu/h) air handler with ECM motor. (40 MBtu/h input / 50 US Gal.)
- Combo 2:** Power vented condensing commercial storage WH coupled with same air handler as Combo 1. (76 MBtu/h input / 50 US Gal.)
- Combo 4:** Manufactured unit, Condensing low mass boiler / 25 to 150 MBtu/h input plus fan coil with ECM motor, Modulating, and DHW Priority.



### 1.

PERFORMANCE RATING									
Thermal Performance Factor (TPF)		0.57							
Annual Electrical Consumption (AEC)		1,112 kWh/yr							
Function-Based Performance Ratings									
Space Heating	CSHE	58 (%)	Space Heating Capacity	7 kW					
Water Heating	WHPF	0.56	One-Hour DHW Delivery Rating (OHR)	398 L					
Recovery Efficiency	RE	71 (%)	OHR	288 L					
Thermal standby loss - Circ fan off		228 W	OHR (measured after test)	288 L					
Thermal standby loss - Circ fan on		133 W							
Selected Test Results									
Space Heating @ PLF 1	Net Efficiency	64 (%)	Average Electricity Use	692 W	460 W	Circulating Blower*			
Space Heating @ PLF 0.4	Net Efficiency	58 (%)	Average Electricity Use	153 W	59 W				
Space Heating @ PLF 0.15	Net Efficiency	55 (%)	Average Electricity Use	80 W	58 W				
			Standby Power (P <sub>standby</sub> )	26 W					
			Standby Power (P <sub>standby</sub> )	5 W					
Consistent Space & DHW Test Results									
Water Drawn at 48 °C with a without concurrent call for heat									
Flow	Time to reach temperature (min)	Time within a 2°C tolerance (min)	Daily Electricity use for water heating (kWh)	0.51 kWh					
	with	without heating call	with	without heating call					
3	0.2	0.2	12.75	Individual					
15	0.2	0.2	7.5	14.5					
				Annual electricity use for water heating (kWh/yr)					
				187 kWh					
Description of Major Combo Components									
Fancoil	Hot-water air handler								
Heat Generator	Power direct vent, 50 US Gallon storage-boiler water heater. No side connections for space heat								
Blower/Motor	Air Handler incorporates a GE 1/3 HP High Efficiency EC Motor								
Other	Air handler incorporates an integral pump								
Test Agency Comments									
Storage tank thermostat set to cut-out at an average temperature of 125°F (52°C) for all tests	Filter Rating	not installed							
Circulating blower in "bypass" mode unless otherwise specified	Segregated DHW System	Yes							
Air Handler controls activate pump "twice" for 30 sec. in a 24 hr. period & no demand for space heating.	Water Circulation	x							
Commissions	DHW Priority	Yes							
		187 kWh							
249 Passes = 1" of Water	1 kW = 3.41 Btu/h								
		Reference Report 10-06-08H-06-1							

**2.**

PERFORMANCE RATING				
Thermal Performance Factor (TPF)	0.68			
Annual Electrical Consumption (AEC)	1173 kWh			
Function-Based Performance Ratings				
Space Heating	CSHE	87 (%)	Space Heating Capacity	7 kW
Water Heating	WHPF	67 (%)	One-Hour DHW Delivery Rating (OHR)	548 L
Recovery Efficiency		85 (%)	OHR (maximum water heat)	491 L
Thermal standby loss - Circ fan off				
Thermal standby loss - Circ fan on				
Selected Test Results				
Space Heating @ PLF 1	Net Efficiency	76 (%)	Average Electricity Use	591 W
Space Heating @ PLF 0.4	Net Efficiency	66 (%)	Average Electricity Use	113 W
Space Heating @ PLF 0.15	Net Efficiency	61 (%)	Average Electricity Use	57 W
			Standby Power (P <sub>stand</sub> )	24 W
			Standby Power (P <sub>circ</sub> )	4 W
				* Measured with blower running
Concurrent Space & DHW Test Results				
Water Cycles at 49.3°C with & without concurrent call for heat			Daily Electricity use for water heating (E <sub>water</sub> )	0.3 kWh
Flow (l/min)	with heating call	without heating call		
	8.2	0.2		
	15	0.2	Annual electricity use for water heating (AE <sub>water</sub> )	110 kWh
Description of Major Combo Components				
Fancoil	Hot-water air handler			
Heat Generator	Power vent, condensing, 50 US Gallon storage-type water heater. Side connections for space heat.			
Blower/Motor	Air Handler incorporates a GE 1/2 H.P. High Efficiency EC Motor			
Other	Air handler incorporates an integral pump			
Test Agency Comments:				
Storage tank thermostat set to cut-out at an average temperature of 105°F (37°C) for all tests	Filter Rating	not installed	MERV	
Circulating blower in 'auto' mode unless otherwise specified	Segregated DHW System	Yes	x No	
Air Handler controls activate pump 'worst' for 30 sec. in a 24 hr. period (no demand for space heating)	Water Circulation	x Yes	No	
Conversions:	DHW Priority	Yes	x No	
249 Pascals = 1" of Water				
1 kW = 3413 Btu/h				
			Reference Report: 10-06-M0144-3	

**4.**

PERFORMANCE RATING				
Thermal Performance Factor (TPF)	0.68			
Annual Electrical Consumption (AEC)	1173 kWh			
Function-Based Performance Ratings				
Space Heating	CSHE	87 (%)	Space Heating Capacity	7 kW
Water Heating	WHPF	67 (%)	One-Hour DHW Delivery Rating (OHR)	548 L
Recovery Efficiency		85 (%)	OHR (maximum water heat)	491 L
Thermal standby loss - Circ fan off				
Thermal standby loss - Circ fan on				
Selected Test Results				
Space Heating @ PLF 1	Net Efficiency	76 (%)	Average Electricity Use	591 W
Space Heating @ PLF 0.4	Net Efficiency	66 (%)	Average Electricity Use	113 W
Space Heating @ PLF 0.15	Net Efficiency	61 (%)	Average Electricity Use	57 W
			Standby Power (P <sub>stand</sub> )	24 W
			Standby Power (P <sub>circ</sub> )	4 W
				* Measured with blower running
Concurrent Space & DHW Test Results				
Water Cycles at 49.3°C with & without concurrent call for heat			Daily Electricity use for water heating (E <sub>water</sub> )	0.3 kWh
Flow (l/min)	with heating call	without heating call		
	8.2	0.2		
	15	0.2	Annual electricity use for water heating (AE <sub>water</sub> )	110 kWh
Description of Major Combo Components				
Commercially available packaged combo system				
GE 3/4 H.P. High Efficiency EC Motor				
Grundfos LPS-4.2 Pump				
Honeywell AM-1 Series Thermostatic Mixing Valve				
Test Agency Comments:				
All tests performed at Head Profile 1" (PF1) setting on Fan Control	Filter Rating	not installed	MERV	
Fan Control 'Storage Feature Timer' set to OFF	Segregated DHW System	x Yes	No	
Circulating blower in 'auto' mode unless otherwise specified	Water Circulation	x Yes	No	
Venting intake - 2" equivalent feet, 2" ABS pipe + terminal	DHW Priority	x Yes	No	
Exhaust - 30 equivalent feet, 3/8" gpc + terminal				
Conversions:			Reference Report: 10-06-M0144-3	
249 Pascals = 1" of Water				
1 kW = 3413 Btu/h				

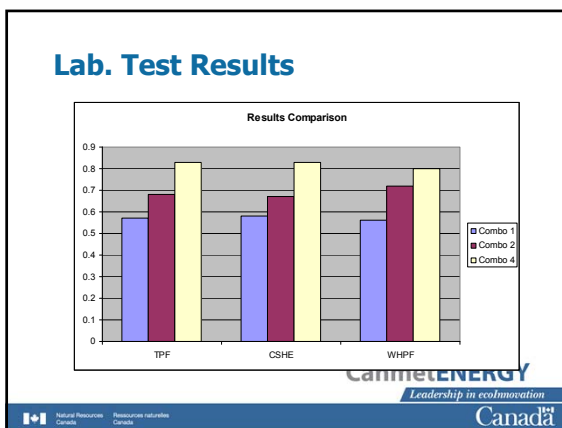

**Combination System Performance**  
Lets Look at Some Field Test Results

The Canadian Centre For Housing Technology (CCHT)

CanmetENERGY  
Leadership in ecoInnovation

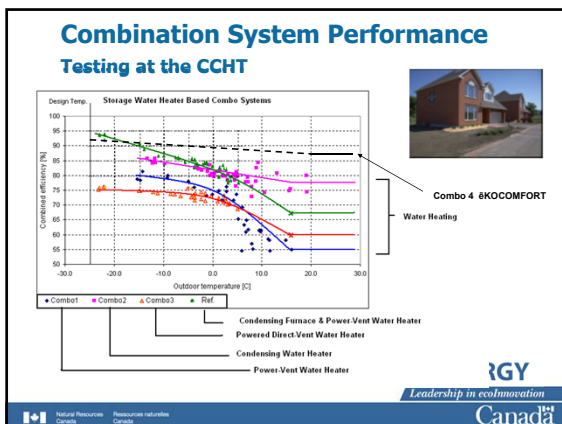

**Combination System Performance**  
Rating Performance

ASHRAE 124 CAE Values

Reference System (Estimated) = 85 %

Combo 1 = 74 %

Combo 2 = 85 %

Combo 3 = 76 %

The ASHRAE 124 is currently being revised

Note that the CAE is weighted heavily towards the space heating efficiency and in this case it does not accurately reflect the superior performance of the Condensing Furnace for space heating.

CanmetENERGY  
Leadership in ecoInnovation

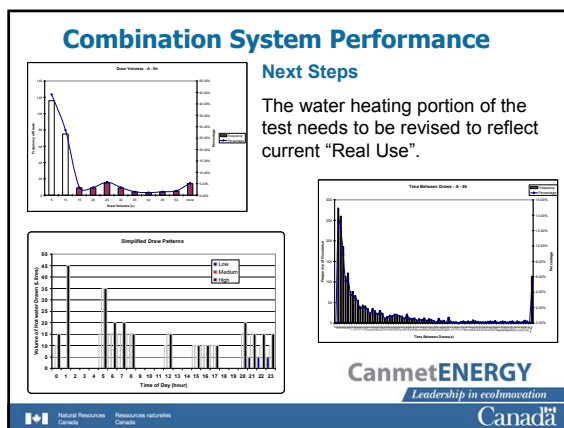
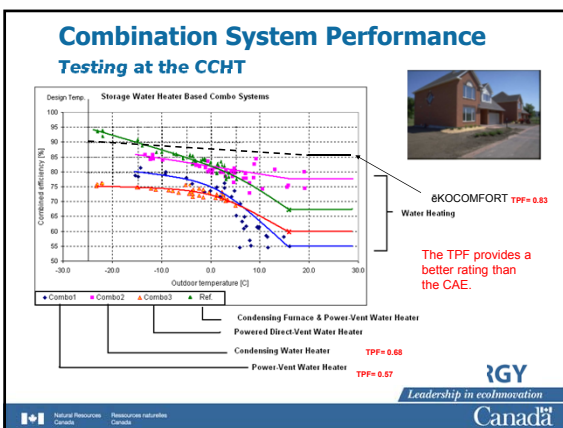
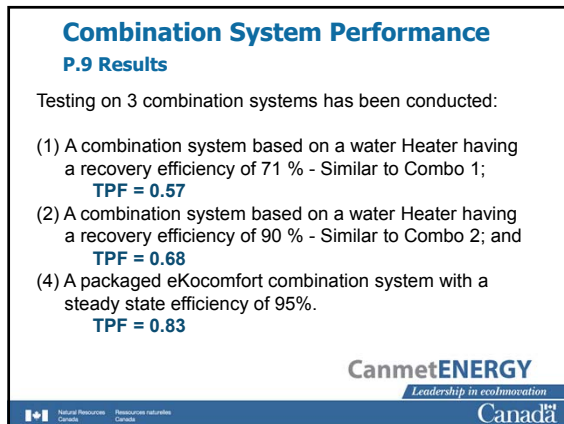
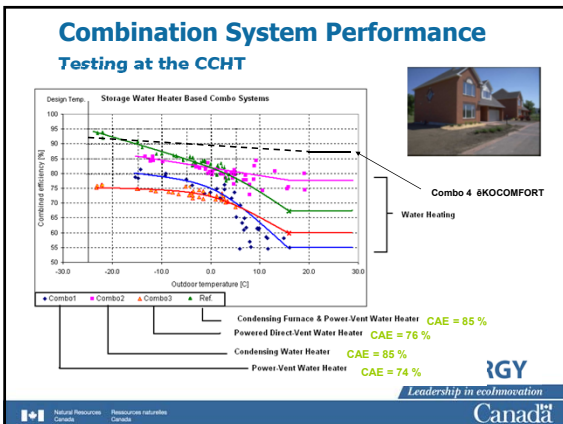

- ### Combination System Performance
- #### Next Steps
- (1) The ASHRAE 124 is currently being reviewed with a view to making some improvements
  - (2) It is possible that we could take elements from the CSA P.9 and incorporate them into the ASHRAE 124 and also develop a suitable test for under-floor or radiator based hydronic heating systems, that could be added to the CSA P.9
  - (3) We are also considering modifying the draw schedule for water heating to more properly reflect today's reality of hot water use (in CSA P.3 & ASHRAE 118.2).
- CanmetENERGY Leadership in eInnovation Canada

- ### Next Steps
- Further testing of different heat generators:
    - Tankless water heater
    - Condensing tankless water heater
    - Boilers, including Oil
    - Oil storage water heaters
  - Inclusion of test for hydronic distribution systems
- CanmetENERGY Leadership in eInnovation Canada



**QUESTIONS**



 Natural Resources Canada / Ressources naturelles Canada 

**Contacts:**

- Martin Thomas,  
(613) 947 0067 or [martinth@nrcan.gc.ca](mailto:martinth@nrcan.gc.ca)
- Rosalyn Cochrane,  
(613) 995 5433 or [rocochra@nrcan.gc.ca](mailto:rocochra@nrcan.gc.ca)

**CanmetENERGY**  
*Leadership in ecoInnovation*

 Natural Resources Canada / Ressources naturelles Canada 

# The Science of Water Heating from a Plumber's Perspective

Harry W. King

Hot Water

1500 Hwy 2985, Shreveport, LA 71205  
 504-835-1234  
 hking@att.net

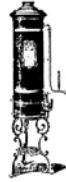

# The Museum



# The Collection



# Sediment



# The Galvanic Series

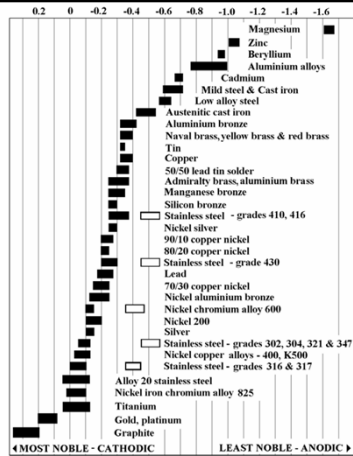

# Erosion



**Dezincification**



**Dielectric - side**

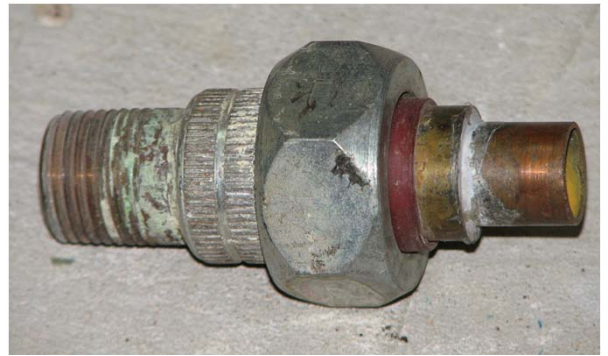

**Dielectric - end**



**Steel vs Brass**



**Brass & Steel 1**



**Brass & Steel 2**



**Glass at Drain**



**Plugged Relief**



**Recirc w/ Copper**



**Slow Leak**



**Lawnmower**



**Backdrafting**



**Fix for Odor**



**Nice Drain**

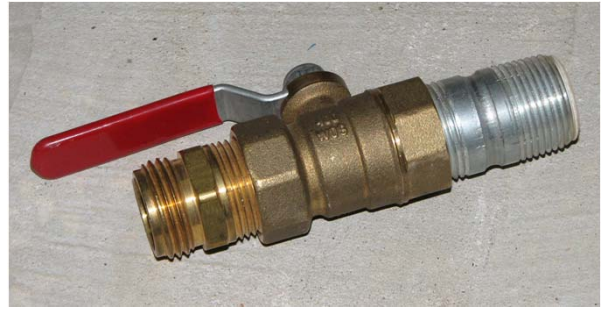

**Old Lined Nipple**



U.S. Department of Energy  
**Energy Efficiency and Renewable Energy**  
 Bringing you a greener future where energy is clean, abundant, secure, and affordable.  
 Building Technologies Program

Field Experience with Tankless Hot Water Heaters Used in Combination Space and Domestic Hot Water Heating Systems

By:  
 Armin Rudd  
 Building Science Corp  
 717.867.0123  
 arudd@buildingscience.com  
[www.buildingscience.com](http://www.buildingscience.com)

For:  
 Combi system expert meeting  
 Westford, MA  
 July 31, 2011

Building Science Consortium

Tankless Hot Water Heater Application with Solar Preheat and Active Storage

Notes:

- 1) Thermostat on electric water heater tank is wired to energize the Taco 013 circulator rather than wired to the resistance element. The thermostat should be set at about 125 F.
- 2) Taco 013 circulator is 1/8 HP and is capable of 5 gpm at 30' head, which is the design pressure loss recommended by Rinnai when pumping through their tankless water heater.
- 3) The outlet of the commercial version of the tankless water heater should be set at 160 F or colder to allow quick recovery. To reduce pump operating time, and (c) to allow at least a 20 F temperature rise across the heater.
- 4) Electric water heater storage tank is available from Whisper at Lowe's.
- 5) This configuration will provide constant temperature at the domestic fixtures and will allow longer cycle time (more efficient operation) of the tankless water heater.
- 6) 8-gallon vent (frictionless) electric water heater storage tank is present (temperature fluctuations at the legs and short-cycling of tankless heater).
- 7) Thermostat on storage tank set to 125 F minimum, but the water can get hotter depending on the solar input.

Building Science Consortium

Notes:

- 1) Thermostat on electric water heater tank is wired to energize the Taco 013 circulator rather than the resistance element.
- 2) Taco 013 circulator is 1/8 HP and is capable of 5 gpm at 30' head, which is the design pressure loss recommended by Rinnai when pumping through their tankless water heater.
- 3) Electric water heater storage tank is available from Whisper at Lowe's, with all the ports necessary. The tankless water heater taps onto the drain valve and pressure/temperature relief ports. The space heating coil loop uses the available side ports.
- 4) This configuration will have the most regulated temperature control at the domestic fixtures, compared to the passive storage system and the system without storage. This system will also have the least short-cycling of the tankless water heater.

Building Science Consortium

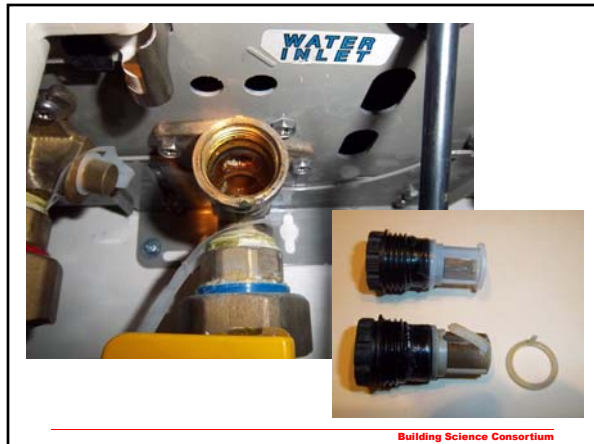

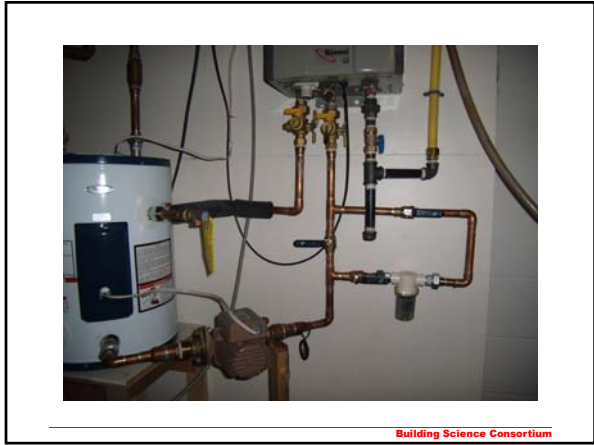
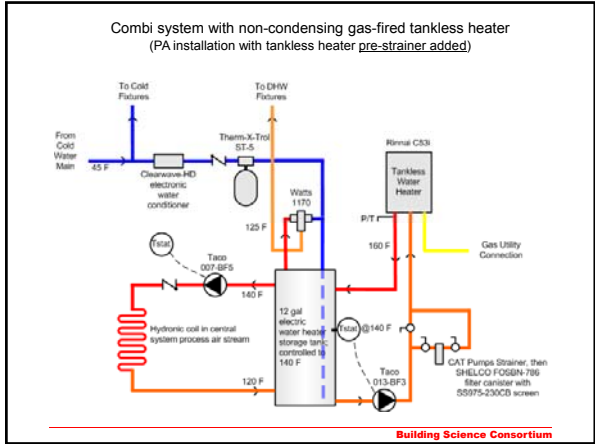
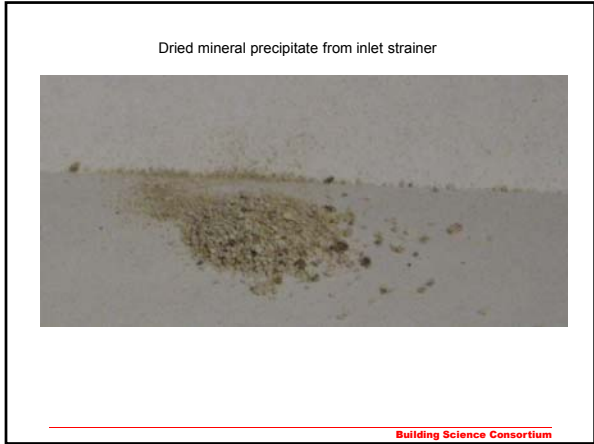

Wire Screen Mesh versus Micron Comparison Chart

Mesh	Micron	
5	3000	
7.5	1980	
10	1480	
16	975	
20	750	
30	500	
40	375	
50	300	
60	238	Rinnai inlet strainer 60 mesh, Shelco strainer 230 micron
80	175	CAT Pumps strainer 80 mesh
100	149	
140	100	
200	74	
250	60	
270	50	
325	40	
400	35	

Building Science Consortium



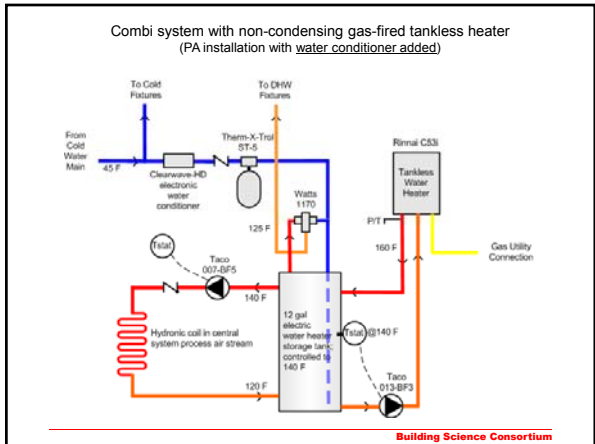
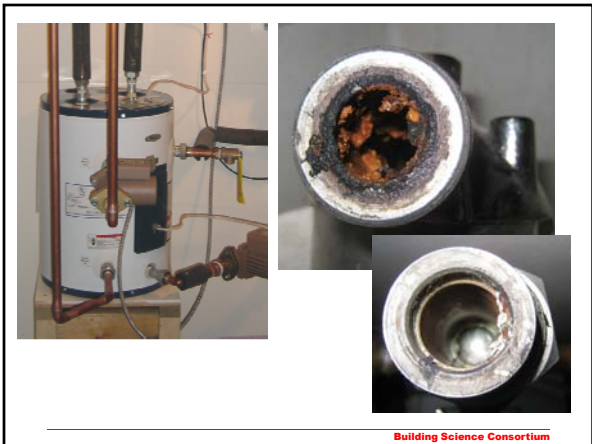



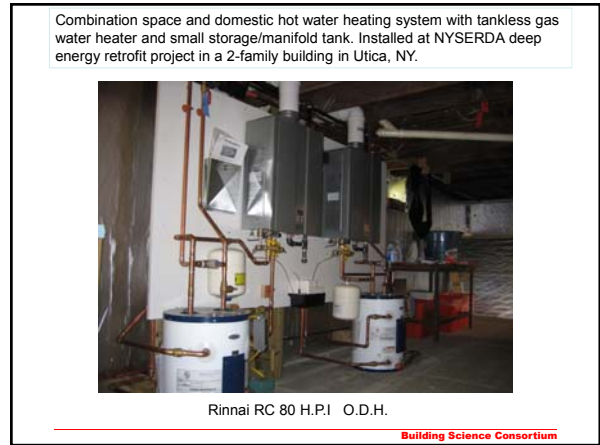
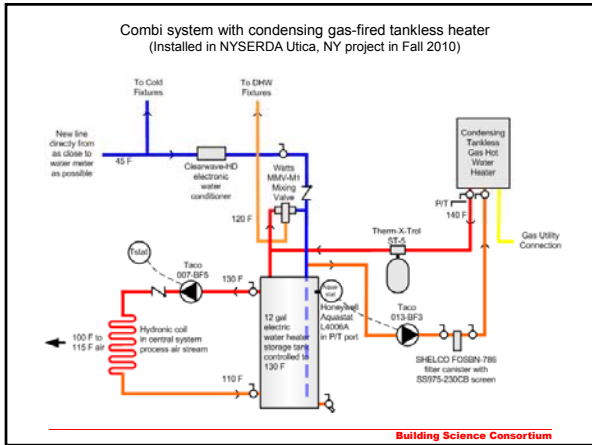

- Cost (sealed bid)**
- Group [A] Heating system  
Labor: \$1,728 plus Materials: \$5,000
- Group [A]  
 2 Rinnai RC 80 H.P.I. O.D.H.  
 2 plumbing kits  
 2 termination kits for Rinnai  
 2 10" vent extensions (polypropylene)  
 2 whirlpool 12 gallon hot water tanks  
 2 Therm-x-trol St-5 expansion tanks  
 2 mixing valves  
 2 clearwave H.D. electronic water conditioners  
 2 Y strainers- Watts 351 M (stainless steel)  
 2 Taco Brass 007 Pumps  
 2 Taco S.S. 013 Pumps  
 2 Rinnai 045 AHB Hydronic Air Handler  
 4 Flow check Valves  
 2 1/2" Drain valves  
 14 3/4" ball valves  
 2 Lex Pro 511 C T-Stat  
 All copper tubing and fittings to complete install  
 All electrical wire and boxes, switches, breakers
- Building Science Consortium**

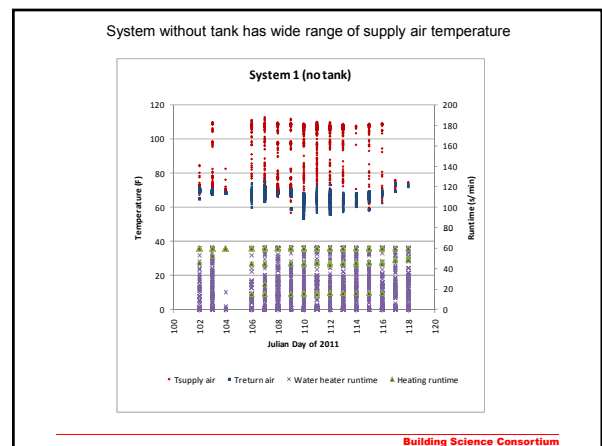
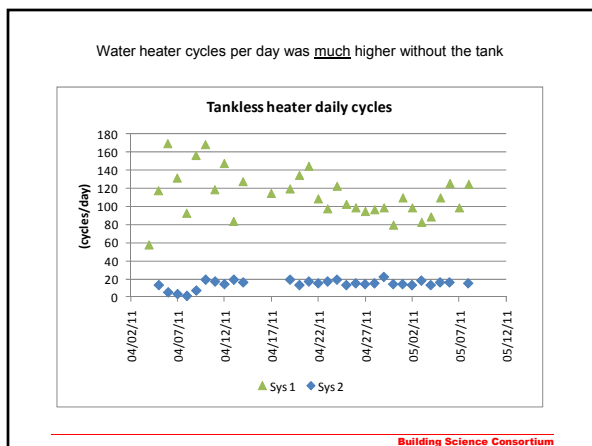
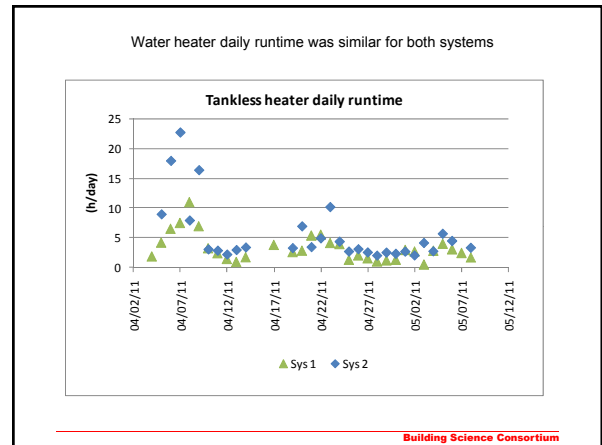
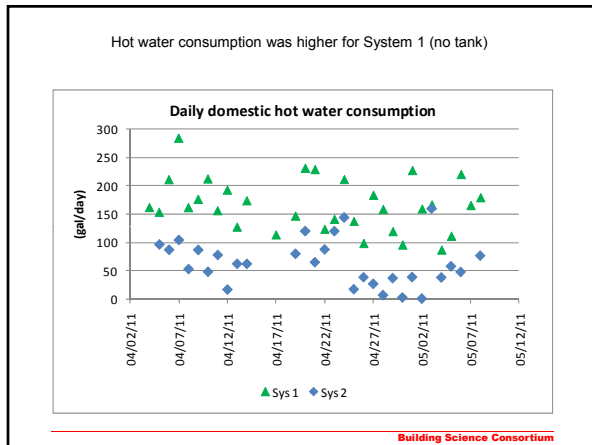
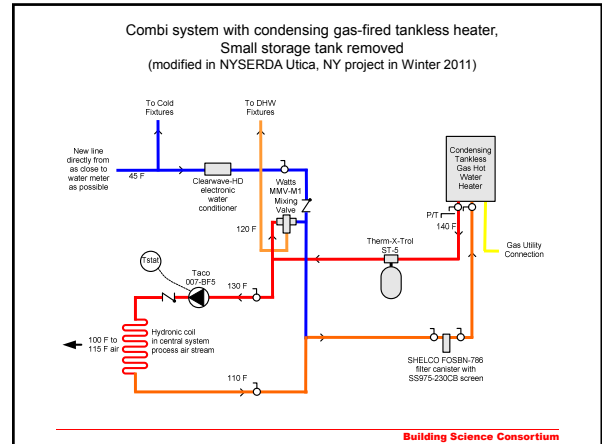

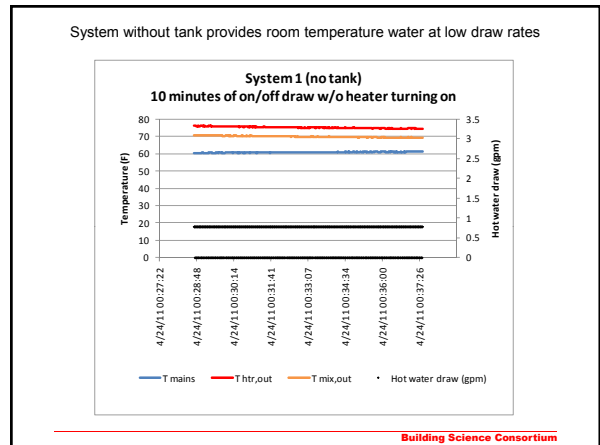
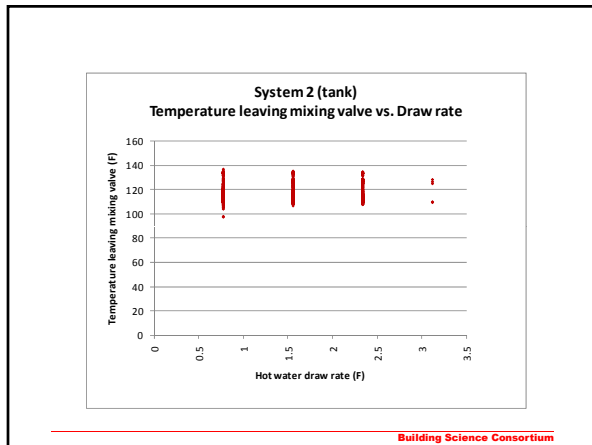
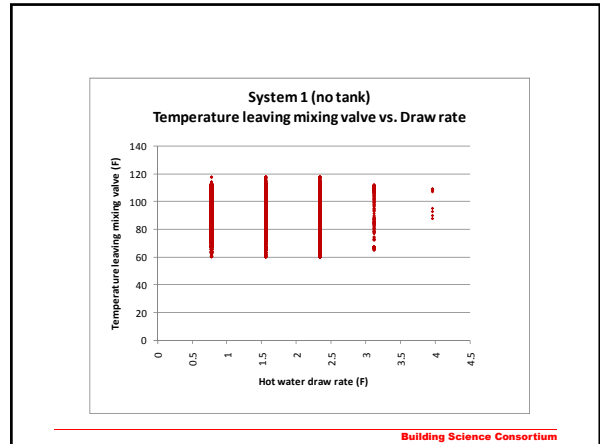
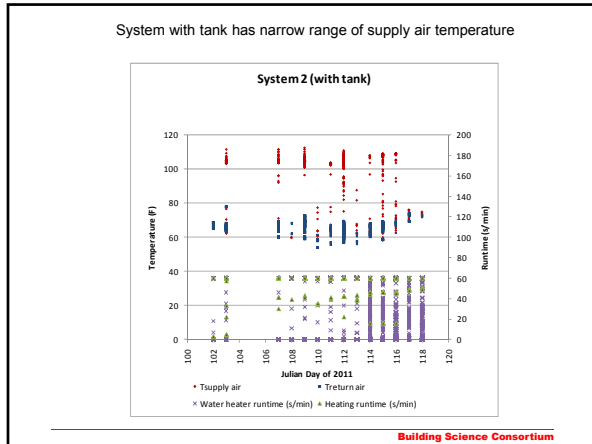

Data Collection

Output channel #	Name	Description	Units	Sensor
1	Array ID	(indicates type of data output as: 1 s, 1 min, 1 h, 1 day, or equipment on/off status)		
2	Year			
3	Jul day			
4	h:min			
5	sec			
6	Tret	heating return air temperature	(F)	Type T thermocouple
7	Tsup	heating supply air temperature	(F)	Type T thermocouple
8	Tmains	mains water temperature	(F)	Type T thermocouple
9	Tmixout	mixing valve water temperature	(F)	Type T thermocouple
10	Tinsup	heating coil inlet water temperature	(F)	Type T thermocouple
11	Ttrout	heating coil outlet water temperature	(F)	Type T thermocouple
12	Tshwint	water heater inlet temperature	(F)	Type T thermocouple
13	Tshwtrout	water heater outlet temperature	(F)	Type T thermocouple
14	ahwOn	air handler unit on/off status		Venr current sensor
15	whwOn	water heater on/off status		Venr current sensor
16	ahwRT	air handler unit runtime	(s)	Venr current sensor
17	whwRT	water heater runtime	(s)	Venr current sensor
18	ahwCycles	air handler unit on/off cycles		Venr current sensor
19	whwCycles	water heater on/off cycles		Venr current sensor
20	ahwWh	air handler unit electrical energy	(W-h)	IMS true RMS watt-hour meter
21	whwWh	water heater electrical energy	(W-h)	IMS true RMS watt-hour meter
22	dhwFlow	water heater water flow	(gal)	Omega water flow meter
23	natgas	water heater gas flow	(cf)	AC-250 temperature compensated gas meter with IMAC pulsar: 125 ft <sup>3</sup> /pulse

Building Science Consortium

Thank you!

Questions?

Building Science Consortium

*buildingamerica.gov*

U.S. DEPARTMENT OF  
**ENERGY** | Energy Efficiency &  
Renewable Energy

DOE/GO-102012-3483 • July 2012

Printed with a renewable-source ink on paper containing at least 50% wastepaper, including 10% post-consumer waste.