

Overview of Building Electrification Technologies and Market Opportunities

National Renewable Energy Laboratory

Kelsea Dombrovski
Heather Goetsch, PhD
Omkar Ghatpande
Jeff Maguire
Kim Trenbath, PhD

November 2024

Overview of Building Electrification Technologies and Market Opportunities

This report provides an overview of building electrification drivers and select building electrification technologies' markets and performance.

Photo by Dennis Schroeder,
NREL 39573

Contents

- 1 Building Electrification Drivers and Context**
- 2 Heat Pumps for Space Conditioning**
- 3 Heat Pump Market Opportunities**
- 4 Life Cycle GHG Emissions Impacts of Heat Pump Space Conditioning Technologies**
- 5 Heat Pump Water Heaters**
- 6 Electrification of Gas Loads: Commercial and Residential**
- 7 Residential Panel Capacity**
- 8 Electric Vehicle Impacts and Connections to Buildings**

Contents Cont'd

9 Building Envelope Improvements and Thermal Energy Storage (TES) Opportunities

Building Electrification Drivers and Context

The High-Level Drivers and Energy Use Context for Further Electrification of Buildings

National Blueprint for the Buildings Sector

[Decarbonizing the U.S. Economy by 2050: A National Blueprint for the Buildings Sector](#) was released April 2, 2024, and is a comprehensive plan to reduce greenhouse gas emissions from buildings by 65% by 2035 and 90% by 2050.

The Blueprint outlines a strategic objective to accelerate on-site emissions reductions in buildings 25% by 2035 and 75% by 2050 vs. 2005. **Five categories of technical solutions for building decarbonization are included in the Blueprint:**

- Energy efficiency
- Efficient electrification
- Grid edge resource management
- Low global warming potential refrigerants
- Low embodied carbon construction

From the list above, this report focuses on **efficient electrification** and touches on several of the other categories.



Why Building Electrification?

CURRENT SCENARIO

Buildings account for 30% of CO₂ emissions in the U.S.

Currently, we rely on burning fossil fuels on-site and off-site to power our buildings.

Mining fossil fuels releases water and air pollution.

Fossil fuel use releases greenhouse gases (GHG), contributing to **climate change**.

Outdoor air pollution can contribute to **poor indoor air quality**.

Air quality is also **compromised** by particulate matter release from combustion of fossil fuels.

60% of U.S. homes currently use natural gas.

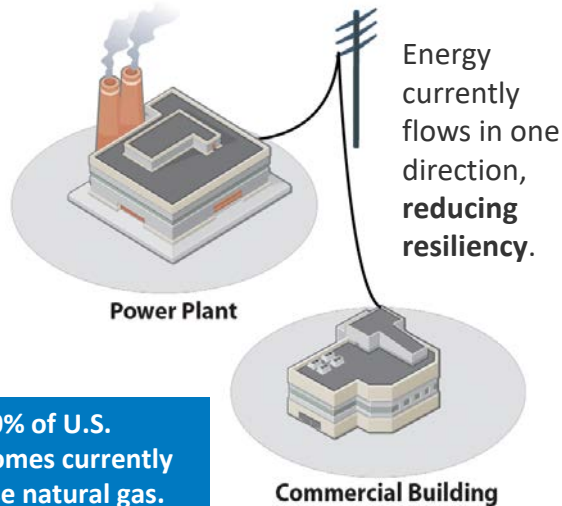

ELECTRIFIED SCENARIO

Electrification is a potential pathway to decarbonization.

Electrification can reduce harmful impacts of fossil fuel use.



Improved indoor air quality because of reduced indoor fossil fuel use.



Upgrading electrical panels to support electric vehicles (EVs) and heat pumps for air and water heating supports further electrification.



New construction **costs are lower with potential time savings** when natural gas is not needed or provided.

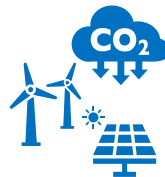

CO₂e associated with electricity production will **decrease with more renewables and emission-free sources**.



Distributed energy resources can provide bidirectional flows of energy.

Space Conditioning and Water Heating Are Major Energy End Uses in Residential and Commercial Buildings

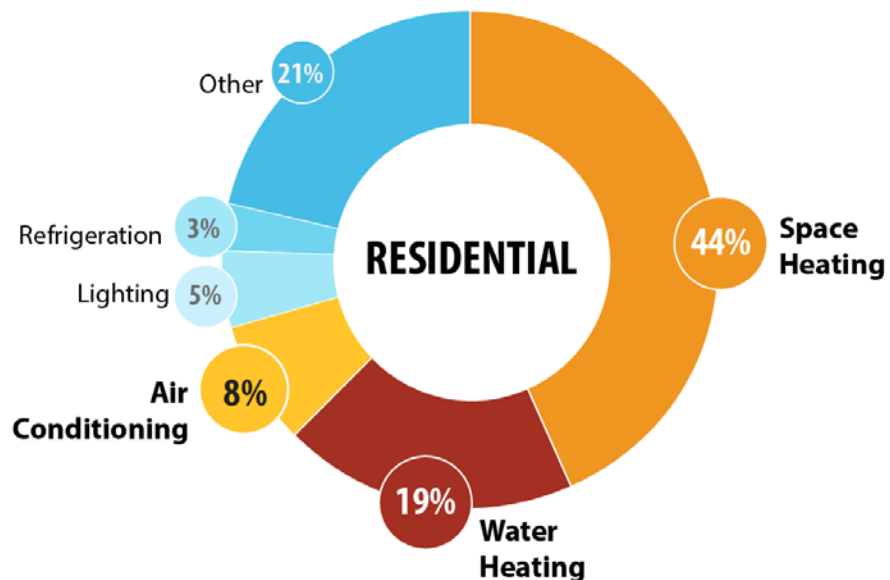

[Source: <https://www.eia.gov/energyexplained/use-of-energy/homes.php>]

Other: Energy for televisions, cooking appliances, clothes washers, clothes dryers, and consumer electronics.

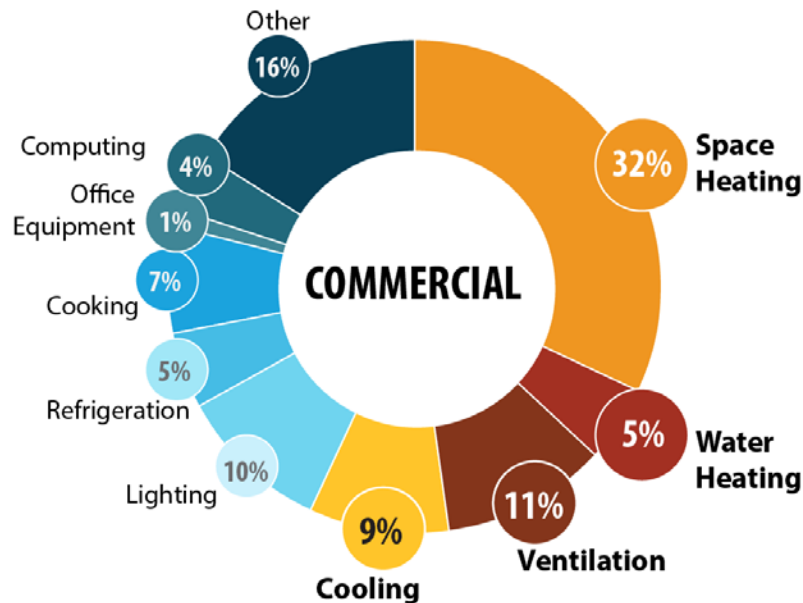

[Source: <https://www.eia.gov/energyexplained/use-of-energy/commercial-buildings.php>]

Other: Miscellaneous plug loads, process equipment, motors, air compressors, and natural gas dryers.

Prevalence of Fuel Uses by End Use Over Time in Residential Buildings

For example, in 2009, 51% of households used electricity for space heating.

- Electricity for all end uses increased from 2009 to 2020.
- Natural gas had moderate increases in most cases.
- Considerable opportunity remains to electrify residential space heating, water heating, and cooking.

[Source: [Residential Energy Consumption Survey Data](#). US Energy Information Administration]

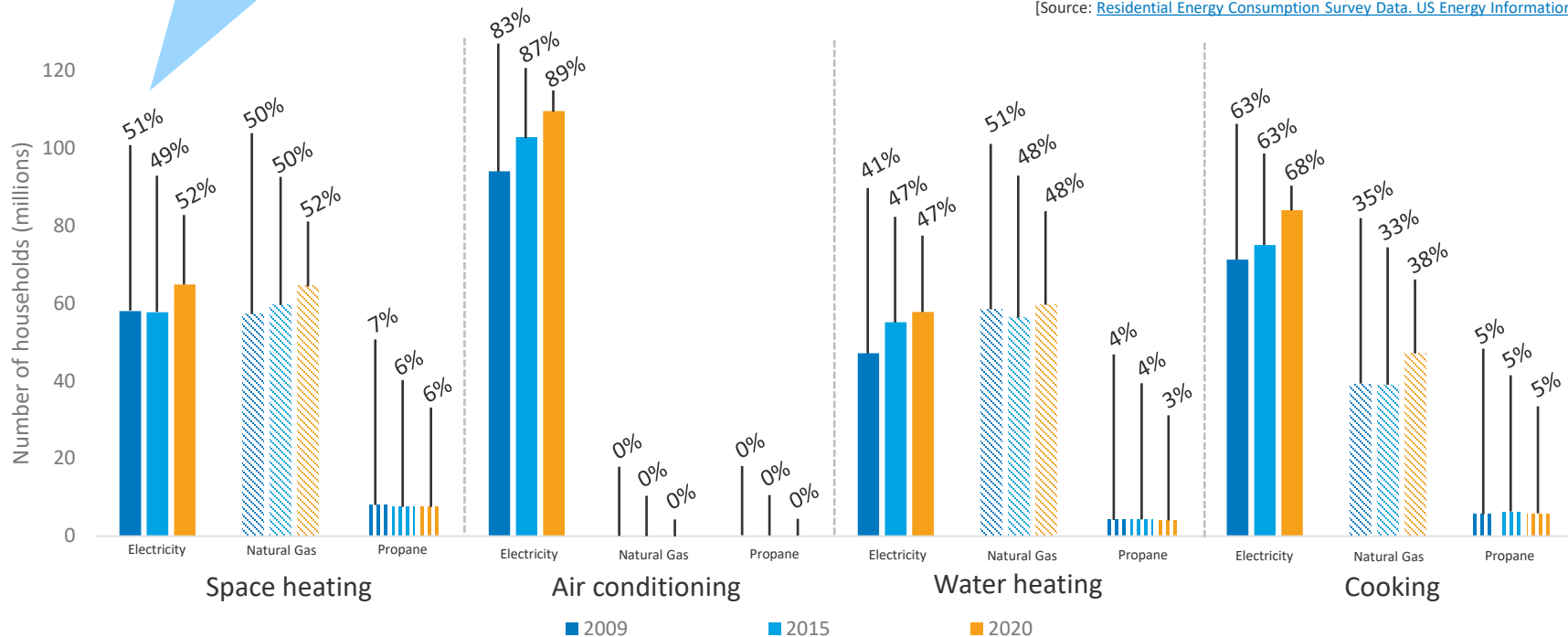

% refers to % of total households in that year that used that fuel type for that end use

*Note that the sum of the % values among different fuel types for a given year and end use may exceed 100% since buildings may use more than one fuel for an end use.

*Note that fuel oil is also not included as a fuel type.

Prevalence of Fuel Uses by End Use Over Time in Commercial Buildings

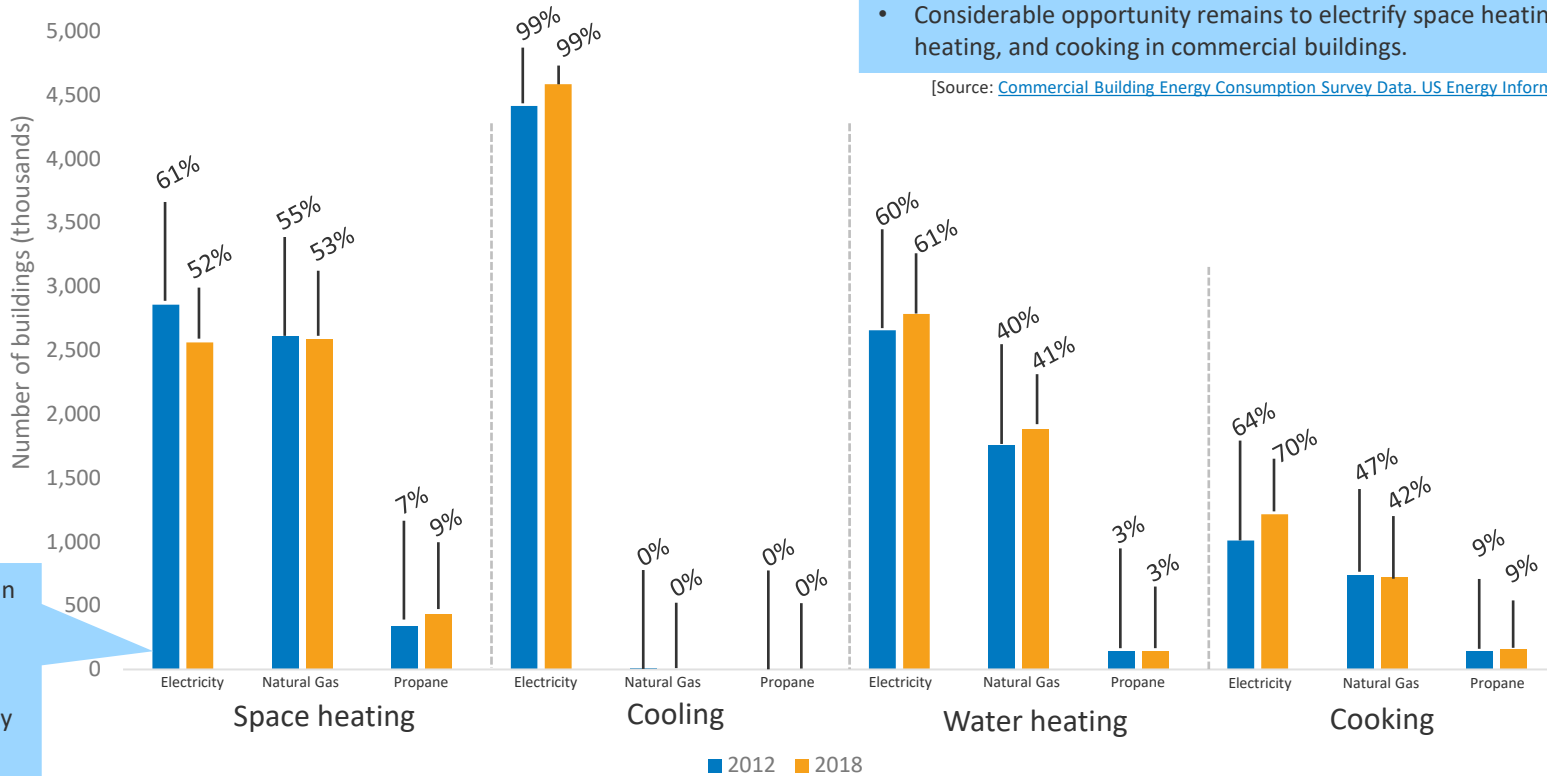

- Cooling is dominated by electricity use.
- Considerable opportunity remains to electrify space heating, water heating, and cooking in commercial buildings.

[Source: [Commercial Building Energy Consumption Survey Data](#), US Energy Information Administration]

For example, in 2012, 61% of buildings with space heating used electricity for space heating.

% refers to % of buildings using the given fuel type that have that end use in that year

*Note that the sum of the % values among different fuel types for a given year and end use may exceed 100% since buildings may use more than one fuel for an end use.

Heat Pumps for Space Conditioning

An Introduction to Heat Pumps for Space Conditioning

Heat Pumps for Space Conditioning

Heat pumps are **electric space conditioning equipment** that provide **both heating and cooling** in buildings. They can function at **higher efficiencies** than conventional electric resistance equipment, providing the **same level of conditioning but using less energy**. Heat pumps transfer heat between spaces: for example, air-source heat pumps exchange heat with the air, and geothermal heat pumps (GHP) exchange heat with the ground. The technology being deployed can be used in both residential and commercial equipment, and when used to replace fossil fuel heating, heat pumps can help buildings **reach building decarbonization goals**.

Different space conditioning and water heating configurations employ heat pumps, including ducted and ductless mini splits often found in residential and smaller commercial settings, and heat pump rooftop units and variable refrigerant flow systems often found in commercial settings. This report's heat pump content focuses on air-to-air heat pumps for space conditioning and air-to-water heat pumps for water heating. Other variations are also important for building decarbonization, including water-to-air and water-to-water heat pumps, and air-to-refrigerant and water-to-refrigerant heat pump heat exchangers.

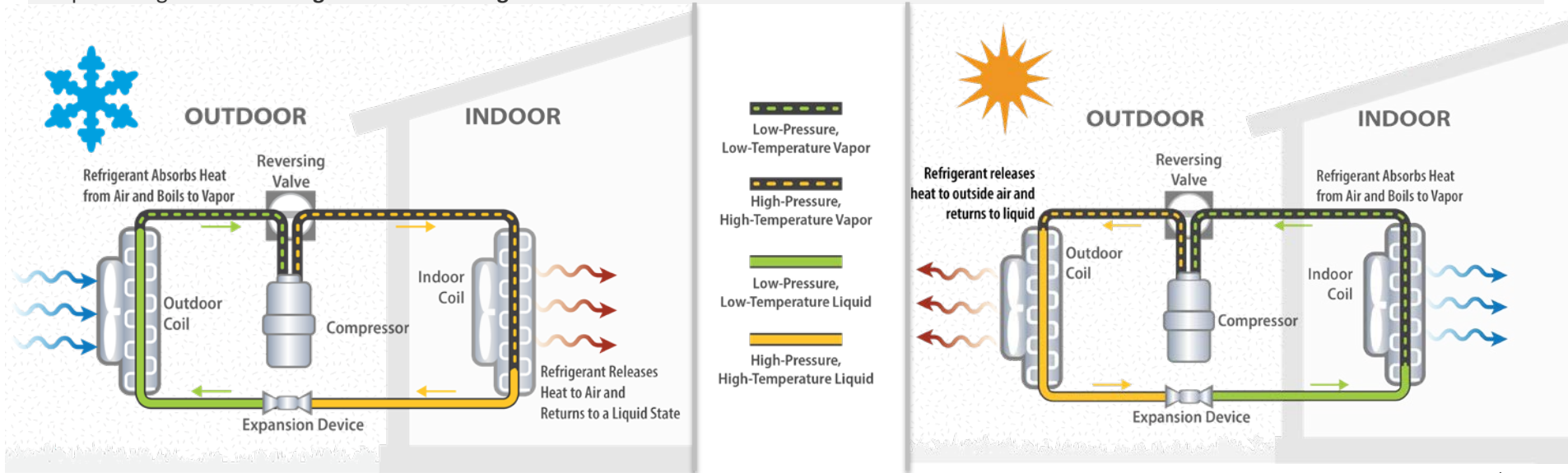

Figure depicts the air-to-air heat pump refrigeration cycle.

Heat Pump HVAC Equipment Deployment Is Changing



“Global sales of heat pumps grew by 11% in 2022” (International Energy Agency [IEA]).*



“In the United States, heat pump purchases exceeded those of gas furnaces” (IEA).

“At current growth rates, heat pumps would nearly double their share of heating in buildings by 2030” (IEA).

* “Heat pumps included in this analysis are electric units used as primary devices for space and/or water heating in buildings and excludes to the extent possible air-air reversible heat pumps units bought primarily for space cooling.”

U.S. HVAC Equipment Shipments

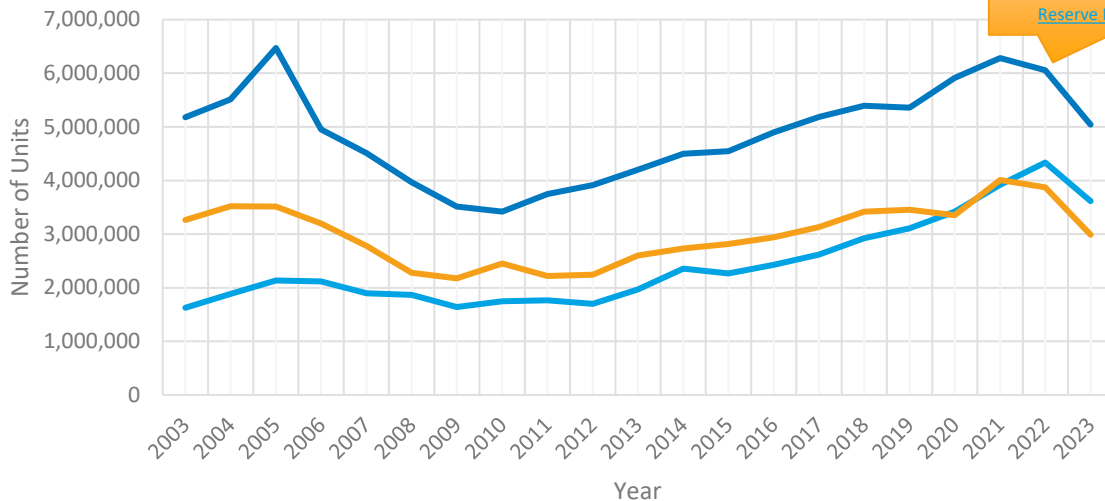

Lower 2023 shipment numbers mirror lower 2023 U.S. housing start numbers. [Source: [Federal Reserve Bank of St. Louis](#)]

“Installations of heat pumps remain concentrated in new buildings and existing single-family homes. **Multistory apartment buildings and commercial spaces will need to be a priority area** if solid growth is to continue.”

[Source: [International Energy Agency](#)]

See the following slides for guidance on **heat pumps in multifamily and commercial buildings.**

Heat Pump Market Opportunities

An Overview of Space Conditioning Applications in Growing Markets: Multifamily Buildings, Commercial Buildings, Small Commercial Buildings, and Colder Climates

Multifamily Building Heat Pump Adoption: Hurdles and Approaches

Multifamily buildings are an important heat pump market: They contain millions of units and are key building types for jurisdictions' climate action goals. Transitioning these buildings from gas to electric heating can be complex and carry different costs compared to traditional equipment, but this change is possible, and support is available.

“The lack of a simple and repeatable [multifamily] heat pump retrofit is a market gap that could potentially be filled by a high-performance packaged terminal unit.

Central heat pump systems may offer superlative performance, but more case studies of successful projects are needed to strengthen the value proposition.”

[Source: [Steven Winter Associates 2019](#)]

Multifamily Technology Type	Retrofit Equipment Cost Estimate, per ft ² *
Baseline: steam or hot water boiler like-for-like replacement	\$1.80
Central heat pumps with hydronic distribution	\$5, existing hydronic system \$15, no existing hydronic system
Packaged terminal heat pumps	\$12
Variable refrigerant flow	\$25
Ground loop with water source heat pumps	\$29

* Does not include labor rates, which vary across the nation. See [report](#) for labor rate estimate map.

[Source: [Steven Winter Associates 2019](#)]

Hurdles to implementing heat pumps in multifamily buildings vary and include financial, structural, and awareness challenges. Methods to clear these hurdles include the following:

- Provide additional contractor training
- Encourage distributor support
- Increase range of financing options
- Simplify rebate applications
- Expand rebates to cover replacing natural gas units
- Produce educational resources for building decision makers.

[Source: [Guidehouse, Inc. 2022](#)]

Incentives, rebates, tax credits, and other types of assistance are available to help with this transition. In addition to local, state, and utility assistance options, [AFFORD](#), [DSIRE](#), and the [Better Buildings Funding and Incentives Resource Hub](#) also provide funding guidance.

Commercial Building Heat Pump Adoption: Modeled Impact

What are the energy and GHG savings if all relevant buildings adopt a specific technology?

[ComStock](#) combines a database of commercial building characteristics, building energy modeling, and high-performance computing to model the **stock-wide impact** of adopting different energy efficiency technologies and packages in the commercial sector.



Commercial stock characteristics database

+



Physics-based computer modeling

+



High-performance computing

Findings from recent heat pump rooftop unit (RTU) measure scenarios from the ComStock publication [End-Use Savings Shapes Measure Documentation: Heat Pump Rooftop Units With Original Fuel Backup](#), analyzing heat pump RTU savings across different backup heat scenarios—with electric resistance backup heat or backup heat that matches the original fuel source in the building.

“Demand in the RTU market is changing, with an increasing number of buyers ordering rooftops units with heat pumps for heating and cooling, rather than models with air conditioner-gas furnace combinations.”

[Source: [ACHR News](#)]

Heat Pump RTUs With Electric Resistance Backup

8.7% SITE ENERGY SAVINGS AND
20–30 MMT AVOIDED ANNUAL GHG EMISSIONS ACROSS 3 ANALYZED GRID SCENARIOS

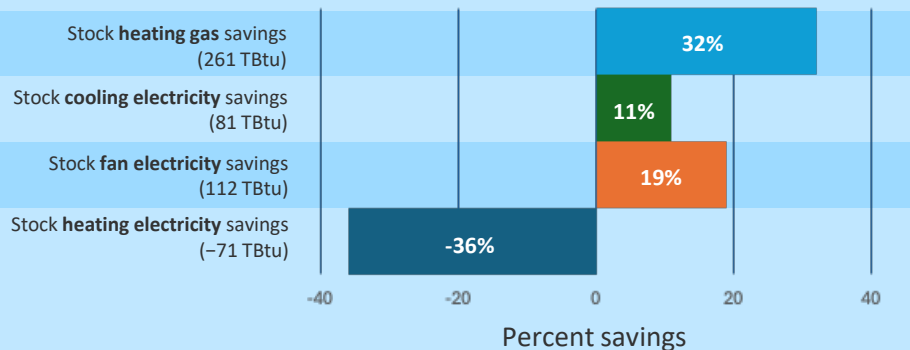

Applicable to ~36% of the ComStock floor area

[Source: [CaraDonna 2024](#)]

Heat Pump RTUs With Original Fuel Backup

8.5% SITE ENERGY SAVINGS AND
20–31 MMT AVOIDED ANNUAL GHG EMISSIONS ACROSS 3 ANALYZED GRID SCENARIOS

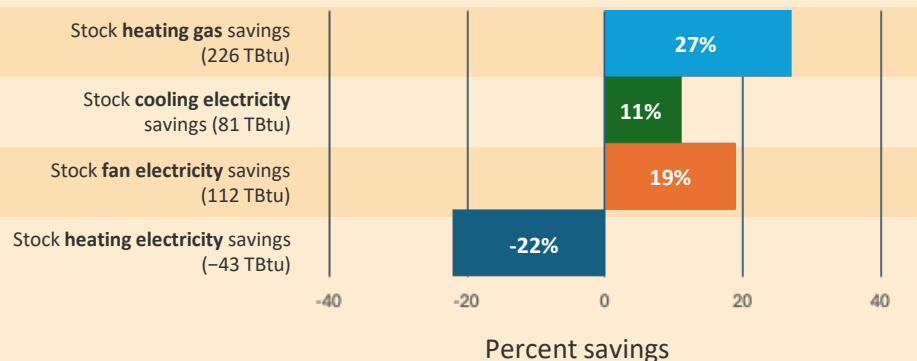

Applicable to ~36% of the ComStock floor area

[Source: [CaraDonna 2024](#)]

Electrification Technology Adoption in Small Commercial Buildings

71% of commercial buildings are <10,000 ft² (representing almost 20% of all commercial building floorspace).

We use commercial buildings <10,000 ft² daily, including chain drugstores, small grocery stores, coffee shops, and urgent care centers.

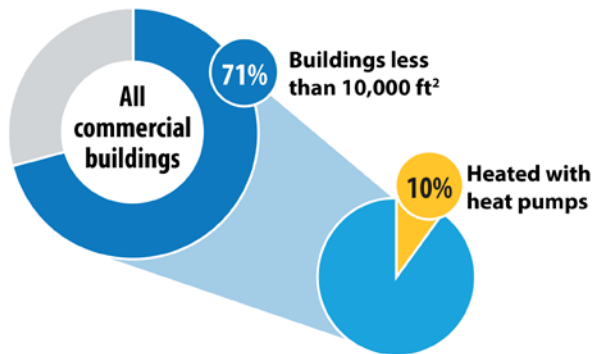

Only 10% of buildings of this size, which represent 10% of small commercial floor space, are heated with heat pumps. This is a market ripe for expanded heat pump adoption.

[Sources: [CBECS 2018](#), Tables B2, B6, B7]

Heat pumps can save energy in small commercial settings:

- **22% heating energy savings** were found in a modeled cold climate scenario of a variable speed air-source heat pump (ASHP) at a 5,502-ft² low-rise office.
- **30% less electricity was used during peak cooling** in a field evaluation of an advanced heat pump RTU at a 6,000-ft² garage workshop.

[Sources: [Shoukas et al. 2022](#); [Woolley 2015](#)]

New technology is more likely to be adopted in newer, larger, energy-intensive, owner-occupied buildings.

In addition, energy-efficient technology adoption in commercial buildings is affected by the **building's location, the activities inside the building, and building-specific characteristics.**

[Source: [Andrews and Krogmann 2009](#)]

Energy cost savings potential, operational considerations, and rebates and incentives motivate efficiency retrofits in small commercial buildings.

Most buildings implement just **one energy saving measure** unless they are at a point in the tenant cycle where adopting more measures makes sense. [Source: [Sherman et al. 2021](#)]

Small building owners have more pressing priorities than energy savings. Specialized engagement and resources are needed to reach these decision makers.

They have fewer resources for researching and implementing energy saving measures, no dedicated energy or building management staff, and **less scalable energy savings compared to larger building and portfolio owners.**

[Sources: [Dombrowski 2023](#); [Frank et al. 2018](#); [Huppert et al. 2013](#); [Langner et al. 2013](#)]



Photos from Pond5.com

Electrification Technology Adoption in Small Commercial Buildings

Heat pump adoption can be affected by many factors: technological, infrastructural, economic, policy, regulatory, and perceived performance [Source: [Gaur 2021](#)]. To increase adoption of heat pumps and other electrification technologies in small commercial buildings, programs and solutions need to focus on the unique needs of the sector.

To succeed in the small commercial market, electrification technologies and programs should consider these characteristics:

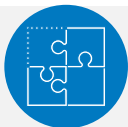

TURNKEY SOLUTIONS WITH LOW REQUIRED INPUTS

Owners need “turnkey” affordable options and clear return on investment to increase adoption of automated fault detection and diagnostics (AFDD), which identify and address issues in the building system to maintain functionality and reduce energy waste. AFDD tools should also have low input data and labor requirements.

[Source: [Frank et al. 2018](#)]



EXISTING PARTNERS, NEW SERVICES

Collaboration with existing HVAC contractors on energy management systems, which help owners optimize energy savings via monitoring and controls, can keep time commitments low for both parties, create new business paths for the contractor, and produce site energy savings of 3%–5%/year for the customer.

[Sources: [Granderson et al. 2017](#); [Frank et al. 2018](#)]



AFFORDABLE AND FLEXIBLE

Energy modeling helps building owners consider the impact of new equipment but can be expensive for small operations. In addition to being an affordable service adjusted for the scale of the property, modeling efforts for small buildings should have flexible technology packages representing different levels of savings that take local building codes into account. [Source: [Strecker 2014](#)]



SYSTEMS TAILORED TO SMALLER APPLICATIONS

There is big growth potential in sensors and controls in small buildings, which help owners monitor equipment performance. However, this technology is often not cost-effective for smaller operations. Developing new systems tailored to smaller applications would help growth in this market.

[Source: [Trenbath et al. 2022](#)]

Commercial space conditioning in smaller buildings is often provided by RTUs, and a growing number of these are heat pump RTUs. The [Smarter Small Buildings Campaign](#), initiated by the U.S. Department of Energy (DOE), works with partners to improve RTU equipment controls and monitoring to increase occupant comfort and decrease energy costs and emissions. The campaign began in 2023 and provides resources and recognition for commercial building owners and managers.

Smarter Small Buildings

Heat Pumps in Colder Climates: Opportunity Across the United States

Successful cold climate heat pump (CCHP) performance is key to expanding the heat pump market. Heating-dominated areas mostly use fossil fuels for heat, making colder areas ripe for heat pump market expansion with equipment types suited to those conditions. This analysis indicates that lower temperatures are not limited to the Midwest and Northeast; cities in the middle U.S. latitudes and north are subject to these temperatures and need equipment to perform under these conditions.

Percentage of Annual Hours Below 25°F, 10°F, and 0°F Thresholds in Major U.S. Cities

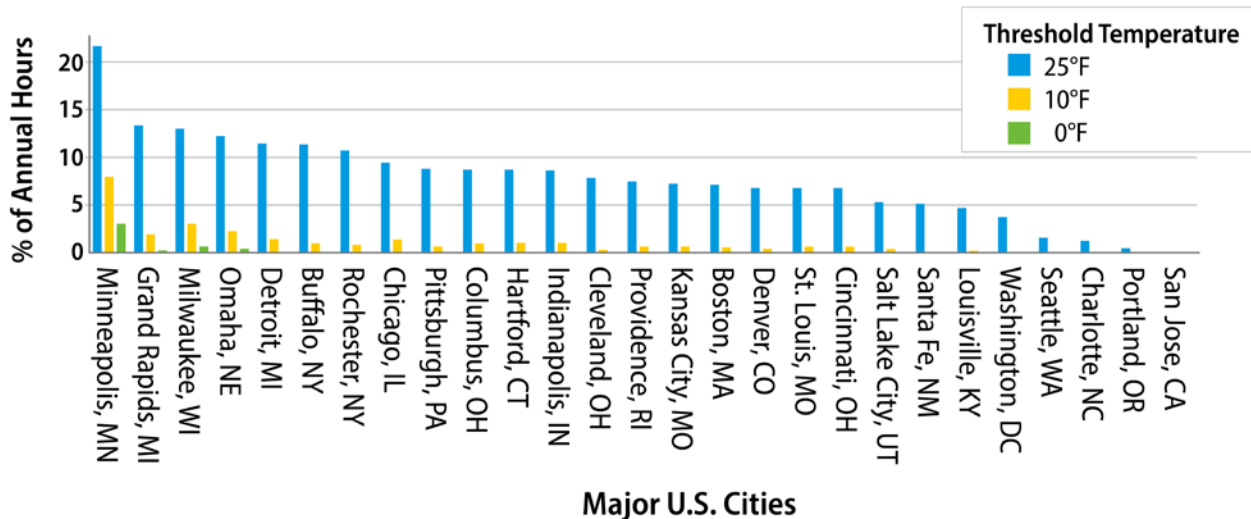

[Source: [Sengupta et al. 2018](#)]

Heat Pumps in Colder Climates: Measured Performance and Goal Specifications

Case studies in colder climates demonstrate **heat pump heating performance in demanding environments.**

Building Type, Location, and Equipment	Case Study Findings
Residential Washington & Montana ducted cold climate (CC) ASHPs	13 systems saw high heating coefficient of performance (COP) from the heat pumps, from 1.5 to >2.5. Rightsizing or upsizing helped reduce usage of electric resistance backup heating. The measured capacity of the units tended to be closer to the minimum manufacturer-reported capacity rather than the maximum. [Source: Winkler and Ramaraj 2023 .] Review additional examples of residential CCHPs in Massachusetts.
Commercial Maine & Connecticut CCHP RTUs	New CCHP RTUs had more than 40% combined space heating and cooling energy savings over the baseline CCHP RTU and provided supply air temperature typically over 100°F . Cost evaluation indicates customer payback under 2 years . [Source: Cogswell and Mahmoud 2020 .]
Residential duplex Minnesota CC ASHPs with electric booster heater	A 2.5-ton CC ASHP with 10-kW electric resistance booster heater was installed in the lower unit of a duplex. Site energy reduction in the unit was 57% . Annual operating cost increased 63% vs. a natural gas furnace given the price difference between electricity and natural gas. Despite outdoor temperatures <0°F for 71.5 total hours during the evaluation season, the HP met over 98% of the annual heating needs and the booster heater was needed only 2% of that time . [Source: Schoenbauer 2018 .]

The U.S. Department of Energy (DOE) is partnering with industry stakeholders to **accelerate the development of heat pump technology** through the [Residential Cold Climate Heat Pump Technology Challenge](#) and the [Better Buildings Commercial Building Heat Pump Accelerator](#).

Manufacturers are developing next-generation heat pump technologies that meet equipment specifications unique to the Challenge and the Accelerator, and building portfolio owners, energy service companies, and other **partners** are supporting improved heat pump performance through information sharing, field validations, and other efforts.

Residential Cold Climate Heat Pump Challenge

Commercial Building Heat Pump Accelerator

Life Cycle GHG Emissions Impacts of Heat Pump Space Conditioning Technologies

Beyond the Operational Carbon Savings of Heat Pumps

Whole Life Cycle GHG Emissions of Heat Pump Technologies

Addressing only the operational stage of HVAC equipment is **not representative** of the entire life cycle, nor does it address all impacts that HVAC equipment, including heat pumps, may have during their lifetimes.

Life cycle assessment (LCA) can be used to **identify high-impact areas** and the **main drivers** of those areas to inform where changes might be made to reduce environmental impacts.

Most studies include life cycle stages **A1 (extraction and processing of raw materials)**, **B1 (refrigerant leakage)**, and **B6 (operational energy)** in their analyses. Limited information and data are available for other stages, indicating a **need for future work** in these areas for a more complete life cycle analysis.

LCA studies from the U.S. and Europe **suggest that HVAC equipment can contribute 11%–15% of the initial embodied carbon of a typical office building**. In addition, **impacts from maintenance and replacement** of this equipment **throughout a 30-year lifetime may be 6 times the value of the initial embodied carbon**, indicating the importance of monitoring ongoing embodied carbon emissions. [Sources: [Rodriguez et al. 2020](#); [Cheshire 2014](#); [Hoxha and Jusselme 2017](#)]

It is important to include **production and construction stages (A1–A5)** because there can be significant **transportation costs for the material and energy needed for installation**.

[Sources: [Violante et al. 2022](#); [Marinelli et al. 2019](#)]

Assumptions of **heat pump lifetimes** will affect the relative impacts of life cycle stages and the overall emissions impacts. The average heat pump lifetime assumption is **20.3 years** (n=15 studies, min 10 years, max 35 years). [Source: [Marinelli et al. 2019](#)]

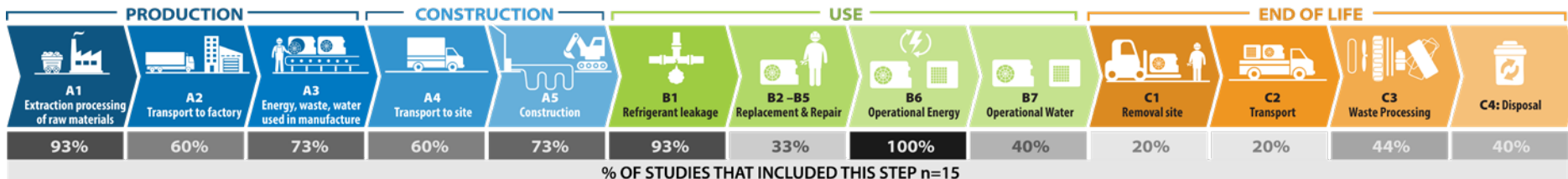

High-Impact Areas Throughout the Heat Pump Life Cycle: Refrigerant Leakage Estimations



Assumptions regarding **refrigerant consumption, losses, and final disposal** are different across studies ([Marinelli et al. 2019](#)).

Greenhouse gas emissions from **refrigerant leakage** make up a **large proportion** of whole life emissions because of the global warming potential (GWP) of refrigerants commonly used.

Types of refrigerants used can greatly impact the overall direct emissions of heat pumps.

Mixture blends of low-GWP refrigerants significantly reduce the direct emissions of heat pumps.

[Sources: [George, Hamot, and Levey 2019](#); [Yang et al. 2021](#); [Johnson 2011](#)]

Heat Pump Type	Common LCA Assumptions for Refrigerant Leakage in Heat Pumps
Air-Source Heat Pump	R134A 3% loss during manufacture; 6% loss during operation (annual) [Source: Greening and Azapagic 2012] R22 Full charge escapes during entire life cycle [Source: Shah et al. 2008]
Water-Source Heat Pump	R134A 3% loss during manufacture; 6% loss during operation (annual) [Source: Greening and Azapagic 2012]
Geothermal Heat Pump	R134A 6% loss during maintenance (annual) [Source: Abusoglu and Sedeeq 2013] R134A 3% loss during manufacture; 6% loss during operation (annual) [Source: Greening and Azapagic 2012] R134A Amount: 0.3 kg/kW, 3% loss during manufacture, 6% loss during operation (annual), 20% loss during disposal, reused at end of life cycle [Source: Saner et al. 2010] R134A Proper disposal of refrigerant and 7.087 g of leakage [Source: Smith et al. 2021] R22 5% accidental leaks (annual) and 25% recycling (annual) [Source: Koroneos and Nanaki 2017] R410A Neglected emissions for the use phase [Source: Russo et al. 2014] R125/R134A/R32 2% leakage (annual) [Source: Heikkila 2008]

Heat Pump Water Heaters

An Introduction to Heat Pump Water Heaters, Emerging Technologies, and Applications

Heat Pump Water Heaters: Overview

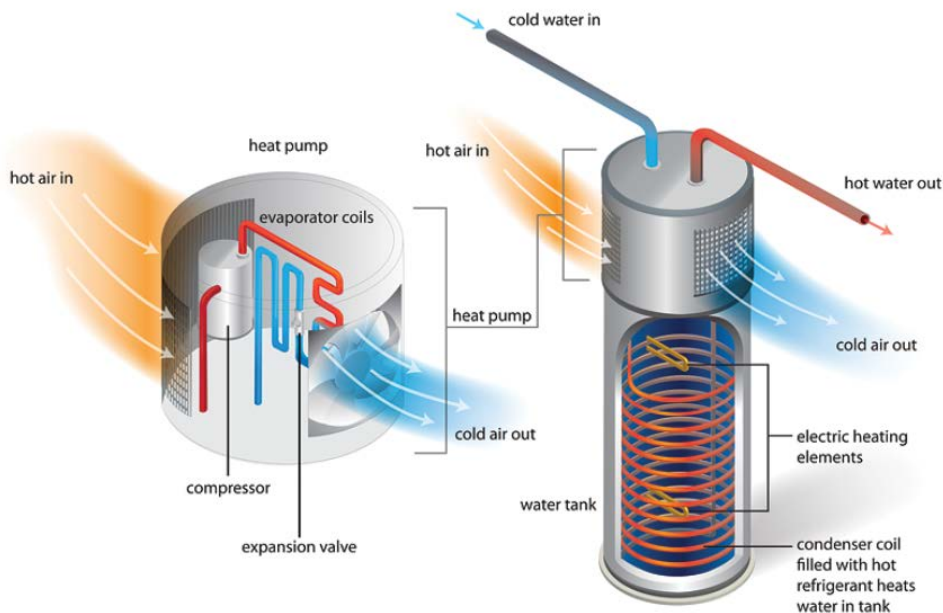

Illustration by Marjorie Schott, NREL

Uniform Energy Factor (UEF)

is a measure of the overall efficiency of a water heater.

Heat pump water heaters (HPWHs) can replace electric resistance water heaters and are substantially more efficient. By taking heat out of the surrounding air and adding it into the tank, HPWHs can achieve a Uniform Energy Factor (UEF) of 4.0 or greater, much higher than the 0.9–0.95 UEF of electric resistance tanks. They can also replace gas water heaters, but additional electrical work may be required to install a 240-V HPWH.

Integrated (where the HP and storage tank are a single unit) 240-V products have been on the market in the U.S. for over a decade, and recent work is focused on 120-V HPWHs for retrofitting homes with gas WHs without an electrical panel upgrade, installing large HPWHs as a central system in multifamily buildings, and a new initiative for small split HPWHs for existing multifamily buildings with space constraints.

When replacing existing water heaters with a HPWH, there are several unique factors to consider:

- If replacing a gas WH, does the electric panel have capacity to support a 240-V HPWH? If not, a 120-V HPWH may be appropriate.
- Will the HPWH fit in the existing space?
- Is there sufficient airflow around the HPWH? In tight spaces, louvered doors, transfer grilles, or short duct runs can be used to provide more air circulation. If not, localized cooling can reduce the performance of this equipment.
- Is there somewhere for condensate to drain?
- Will the noise (~50 dB, equivalent to light traffic noise or a running dishwasher) be a problem for occupants?

Load Shifting With Heat Pump Water Heaters

All tank water heaters have inherent storage from the tank volume, making them ideal for load shifting applications.

- Less noticeable for occupants than changing space temperatures:
 - So long as showers are hot, people are not very sensitive to when their water heater runs.
- For occupants with a time-of-use (TOU) utility rate or demand charges, loads can be shifted from more expensive peak periods to off peak or to reduce peak demand to save on utility bills.
- HPWHs include a communication port to allow utilities to send signals using the [CTA-2045](#) protocol to add or shed load. Commands can be sent to water heaters to “basic load up” (BLU) or “load shed,” shifting energy use away from periods when other utility loads or electricity rates may be higher. Occupants are paid for allowing this control.
- Occupants can also use the manufacturer’s app to schedule set points for the water heater, shifting loads out of peak periods of TOU rates.
- For water heaters with CTA-2045B and a thermostatic mixing valve, “advanced load up” (ALU) commands can be sent, which increase set point and the amount of load that can be shifted.
- Large central water heaters can also shift loads, but the amount of shiftable load varies based on application and is site-specific.

[Source: [Methods for Estimating Load Shift Potential in Commercial Heat Pump Water Heating Systems](#)]

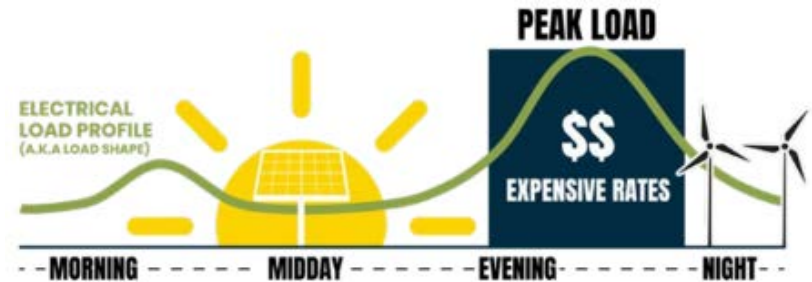

[Source: [Field Monitoring Advanced Load Shifting Controls for 120 V HPWHs](#)]

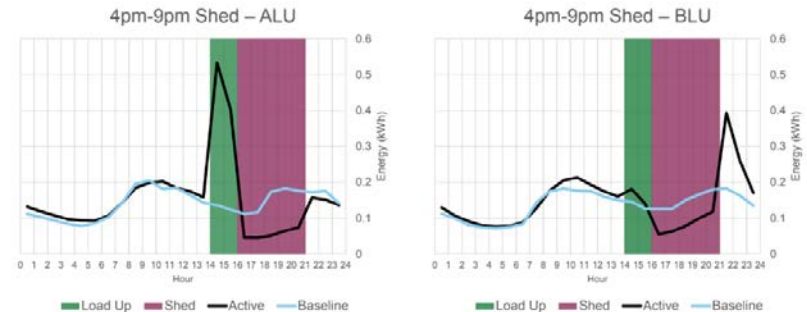

Load shifting through CTA commands can shift loads away from peak periods, helping the grid and reducing utility bills.

[Source: [Thermal Storage Load Shifting: Lessons learned from GP&E WaterSaver Program](#)]

Residential Heat Pump Water Heater Adoption

Residential Water Heater Shipments by Year

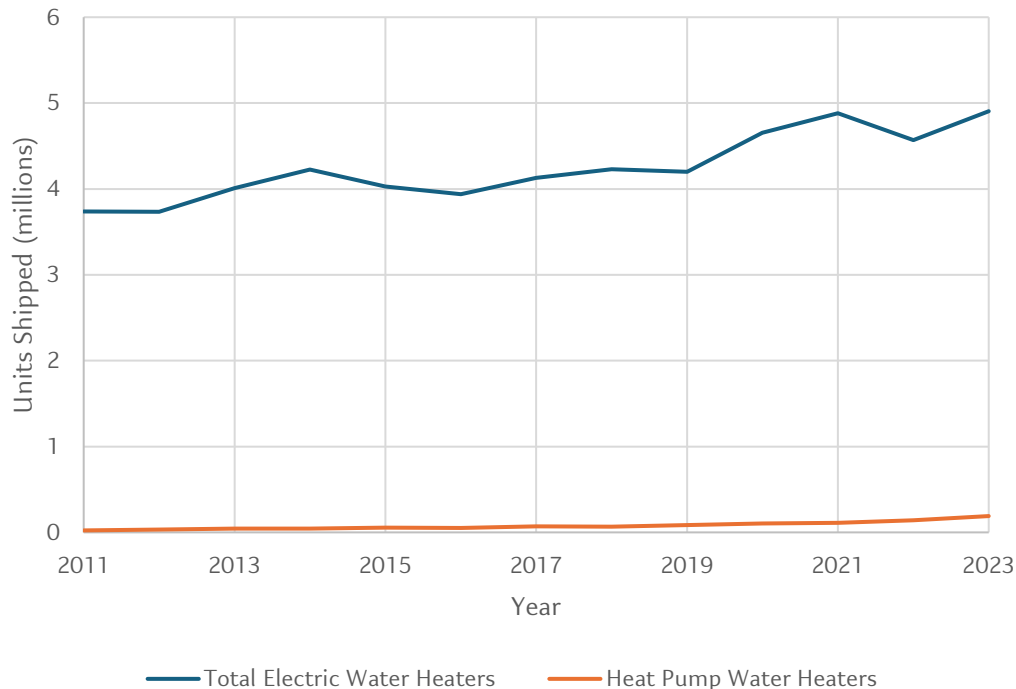

Total shipments from [AHRI data](#) and HPWH shipments from [EnergyStar](#)

Year	% of Residential Electric Water Heater Shipments
2012	0.9%
2014	1.1%
2016	1.3%
2018	1.5%
2020	2.2%
2022	3.1%
2023	3.9%

- HPWHs are a small but growing portion of the residential market.
- Ramping up, with a ~40% increase year over year since 2020. 2023 saw the biggest increase of 50,000 additional units sold.
- Sales are not uniform, with most units sold in either the Pacific Northwest or Maine.
- Effective engagement and support programs have been the most important factor in where HPWHs are sold.

120-V Plug-In HPWHs

- It is hard for many homes with gas water heaters to electrify to 240-V HPWH without some electrical work, which requires an electrician and which added \$2,700 to the average installation cost in California. [Source: [TECH Clean California Data](#)]
- An existing unused 30-A circuit is needed to install traditional 240-V HPWHs.
- 120-V HPWHs can circumvent this challenge and are now available from multiple manufacturers to meet this market; 120-V HPWHs are a solution for retrofit projects, replacing gas water heaters.
- 120-V HPWHs are less efficient and require a larger room to be installed in than 240-V HPWHs.
 - Install a 240-V if no electrical work is required.
- Lower power leads to lower first hour rating (FHR) and longer recovery times:
 - Not suitable for all homes, sizing is key to ensure adequate hot water.
- Not all manufacturers of 120-V HPWHs include backup electric resistance elements, so the unit needs to be in a space where the HP can always run. Backup elements can ensure hot water is available if installed in a space that occasionally gets too cold for the heat pump to run, like in a garage or outside.

First Hour Rating (FHR)

is the maximum volume of hot water a tank water heater can supply in one hour.

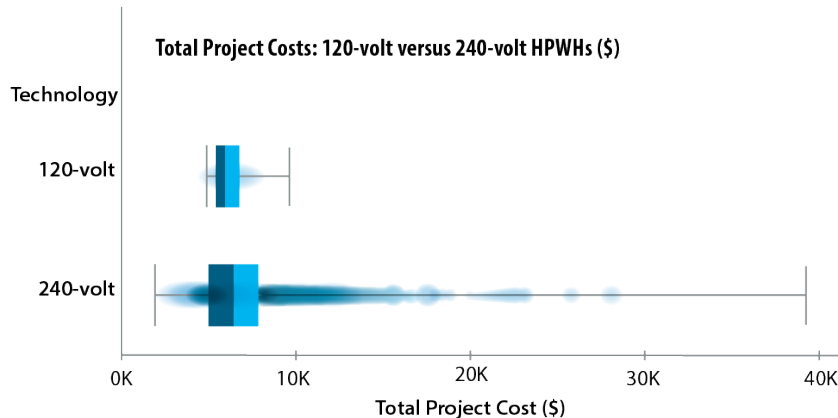
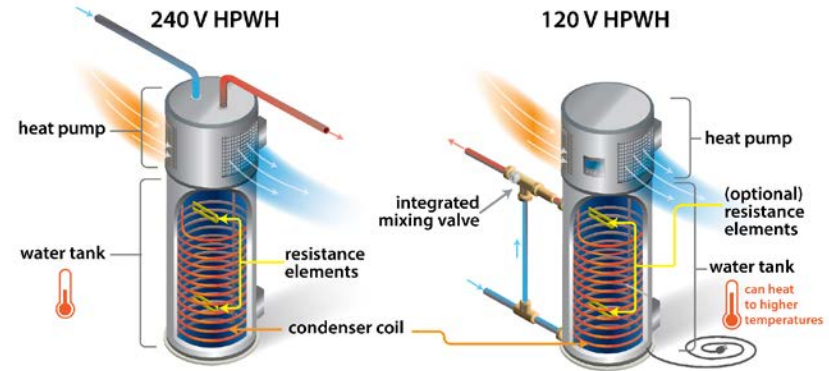

Total installed cost for 120-V versus 240-V HPWHs in CA. The midline is average costs, and blue bars are the interquartile range. Panel upgrades substantially increased the overall installation costs. Note 240-V includes large central HPWHs in multifamily buildings, which are more expensive.

[Sources: [TECH Clean California Data](#); [Plug-In Heat Pump Water Heater Field Study Findings and Market Commercialization Recommendations](#)]

120-V Plug-In HPWH Field Studies

- As this is a new technology, multiple field tests are underway to understand 120-V HPWH performance and satisfaction.
- Field testing has been completed in California and is ongoing in New Orleans and the upper Midwest.
 - [Sources: [120-volt Heat Pump Water Heater Technology Validation and Commercialization](#); [Challenges and Opportunities from 120 V Heat Pump Water Heater Deployment in New Orleans](#); [Midwest 120 V HPWH Field Study](#)]
- Key takeaways from the field:
 - Most people were happy with their 120-V HPWH.
 - Installation can still be time-consuming but may get easier as plumbers become more familiar with these products.
 - Larger tank sizes are needed compared to existing water heaters to avoid runoff:
 - Higher set point temperatures and a tempering valve can also help.
 - Even in hot climates, do not install outside:
 - Heat pump does not run below 37°F, so if it ever gets below that temperature and there are no electric resistance elements—there is no hot water.

California Field Pilot

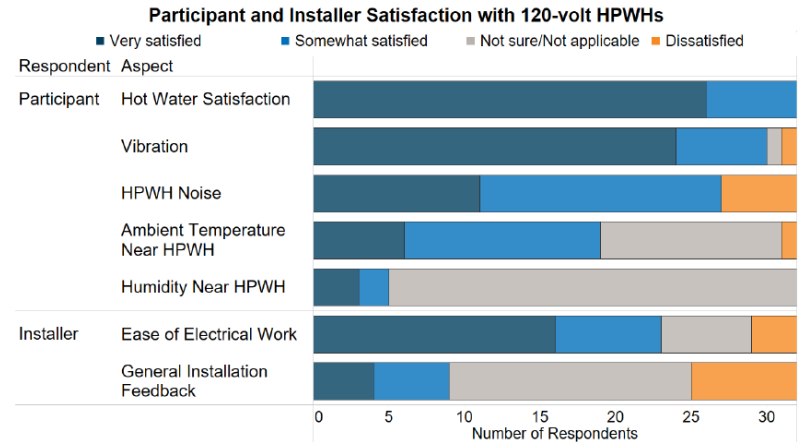

[Source: [Plug-In Heat Pump Water Heater Field Study Findings and Market Commercialization Recommendations](#)]

Midwest Field Pilot

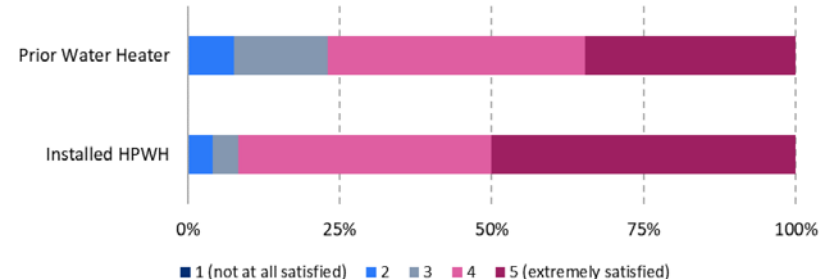

[Source: [120 V HPWH Field Study: Interim Results](#)]

HPWHs in Multifamily Buildings With In-Unit Water Heaters

- Builders want a new product for multifamily dwellings with small in-unit water heaters.
- Existing multifamily buildings with in-unit water heaters are difficult to retrofit with HPWHs.
 - Sound, exhaust, ventilation, and space are all significant challenges for retrofits.
 - Similar issues exist in manufactured housing.
- NEEA held a design charrette around barriers and solutions for installing HPWHs in multifamily buildings.
[Source: [HPWHs in Multifamily New Construction: Design Charrette Findings](#)]
- The charrette found architects, plumbers, and builders all wanted a small split system (with the heat pump outside and the tank inside) for these buildings, but no competitively priced product currently exists.
 - Possible to design new buildings to deal with some of these issues but requires substantial changes to existing design and no easy way to retrofit existing systems.
- NEEA announced the Hot Water Innovation Prize, providing funds to any manufacturer who can design a product for this market. [Source: [Hot Water Solutions](#)]
- Market is ~1 million units/year.

Challenges to HPWH Adoption in Multifamily



Sound

Difficult to isolate HPWH from living spaces



Exhaust

Limited options for where to discharge cool exhaust air



Ventilation

More challenging to ensure ventilation that provides sufficient heat for heat pump



Space

HPWHs are larger than ER – Particularly challenging when replacing a small form-factor water heater

Heat Pump Water Heaters in Multifamily New Construction: Design Charrette Findings⁶

[Source: [HPWH Form Factors for Multifamily Dwelling Installations](#)]. Note ER is "electric resistance" water heaters.

Multifamily HPWH Specification Draft

Split System Design

- Outdoor air source
- Heat pump unit on, or in, wall
- 50 foot separation
- 2-3 hour installation

Ambient Temperature Range

- Compressor range:
 - Minimum model: 37 - 100 °F
 - Cold climate model: 5 - 110 °F
- Withstand 24 hrs without power:
 - Minimum model: at 20°F
 - Cold climate model: at -5°F

Energy Input

- Max: 12 Amps at 120 Volts

Performance

- Efficiency: SCOP \geq 2.4
- FHR: \geq 38 gallons
- Output Capacity: \geq 1 kW
- Meets ENERGY STAR[®] standards

Storage Tank Dimensions

- Max: 24" x 26" x 36"

Sound Level

- Max: 50 dBA at 1m

Controls

- Access within dwelling
- EcoPort[™] built in

Condensate

- Disposed without dripping or depositing outside

Dependability

- No maintenance required by user
- 10-year warranty on heat pump
- Industry standard tank warranty

Market Support

- Installer training program
- Product launch campaign
- Installation manual
- Technical support

Equipment Price

- Competitive enough to sell

[Source: [HPWH Form Factors for Multifamily Dwelling Installations](#)]

Central HPWH

- 33% of Americans live in multifamily buildings. 55% of multifamily buildings have a central water heater or boiler that serves all units, rather than in-unit water heaters.

[Sources: [RentCafe: The Decade in Housing Trends](#), [Residential Energy Consumption Survey](#)]

- 43% of residential starts in 2022 were multifamily buildings.

[Source: [New Construction in 2023](#)]

- In the northwest, 67% of multifamily dwellings have in-unit water heaters and 33% have central systems.

[Source: [Residential Building Stock Assessment](#)]

- Larger buildings are more likely to have central systems.

- Central HPWHs can efficiently replace existing gas or electric central water heaters.

- COP of 2 or greater.
- Electric has a maximum efficiency of 1, gas of less than 1.

- Central HPWH installations require more design engineering—there are many options.

- There is no “one size fits all” solution like an integrated HPWH for single-family buildings.



[Source: [Central CO₂ HPWH Performance and Load Shifting in Multifamily Buildings](#)]



[Source: [Central HPWH Design Guide](#)]

Central HPWH: Design Resources

- Central HPWH systems are generally custom engineered; there are a lot of configuration options.
- Central HPWHs are not sized like traditional boilers. Incorrect sizing will lead to poor performance.
- Central HPWHs commonly feature a “swing tank.”
 - Most multifamily buildings have a recirculation loop that runs constantly to ensure hot water is quickly available. Using a HP to meet that load would require frequent cycling, which gives poor performance and reduces lifetime. The swing tank reheats recirculation losses using an electric element or gas burner.
- To aid engineers in sizing and designing a central HPWH, there is a new design guide discussing configurations, the pros and cons of each layout, different refrigerants, and other considerations for getting the best performance out of a central system. [Source: [Central Heat Pump Water Heater Design Guide](#)]
- The Ecosizer tool can also be used for sizing central HPWH systems. [Source: [Ecosizer](#)]
 - Allows for input of design conditions, multiple configurations, and load shifting. Ecosizer performs simulations to ensure all loads are met, the overall efficiency of the system, and how much load may be shifted (if desired). Ecosizer allows users to understand how their system will perform under the specific loads of a given building and the trade-offs of different configurations.

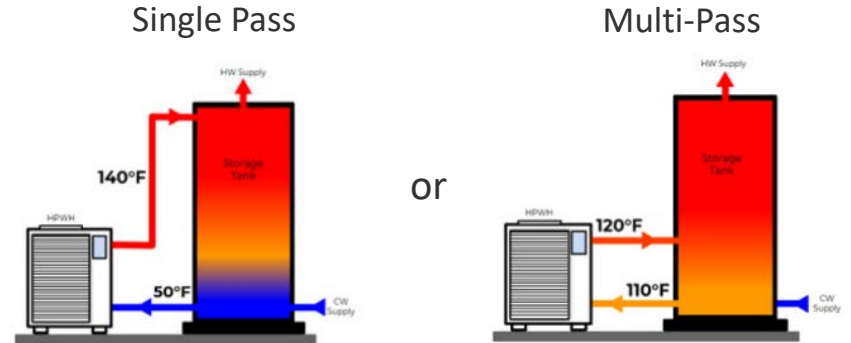

Depending on equipment size and type, the system may be designed to fully heat water in a single pass or require multiple passes. Different configurations use different products and refrigerants. [Source: [Central HPWH Design Guide](#)]

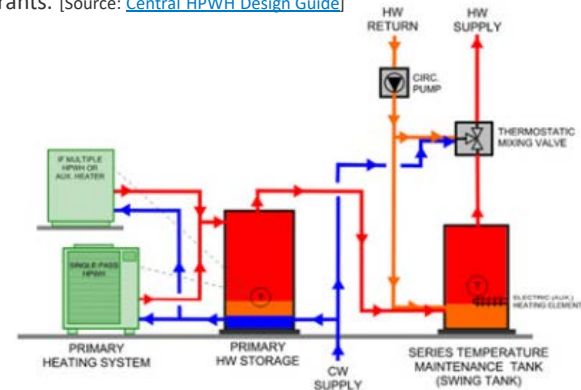

One (of many) possible central HPWH configurations with a swing tank. [Source: [Central HPWH Design Guide](#)]

Central HPWH Field Studies

- Central HPWHs can work in different climate zones, for different numbers of units.
- COP of at least 2.
- Northwest Energy Efficiency Alliance (NEEA) has done analysis of the supply chain for central HPWHs. [Source: [NEEA](#)]
- More field tests are ongoing.

[Source: [Commercial and Multifamily CO₂ Heat Pump Water Heater Market Study and Field Demonstration](#)]

System Description	Location	Number of Dwellings	COP	DHW Usage (gal/person/day)	Cost	Sources
New construction R134a single pass HPWHs in parking garages	Seattle, WA	92 and 118	2.4–2.8 (annual)	13 and 19	N/A	Heller and Oram 2015
New construction outdoor HPWH coupled with indoor electric resistance (ER) storage	Davis, CA	12 (dorms)	2.12 (annual)	12.3	N/A	Hoeschele and Weitzel 2017
Retrofit CO ₂ heat pumps with storage tanks and ER swing tank	Seattle, WA	60 (apartments)	3.3 (monitoring period)	20	\$1964 per residence	Banks, Grist, and Heller 2020
Retrofit CO ₂ heat pumps with storage tanks and ER swing tank	Seattle, WA	100 (low-income senior housing)	2.3 (monitoring period)	18	N/A	Banks, Spielman, and Heller 2022
New construction CO ₂ HPWH with storage tanks and ER swing tank	Sunnyvale, CA	66 (apartments)	3–5 (monitoring period)	20.7	N/A	Dryden et al. 2023
New construction central HPWH planning	New York, NY, and Bay Area, CA	N/A	N/A	N/A	\$1,110–\$3540 per residence	Gartman and Armstrong 2020
Retrofit central HPWH cost planning	N/A	N/A	N/A	N/A	\$1.5–3 per ft ² of living space	Steven Winter Associates 2019
Retrofit CO ₂ heat pumps with storage tanks and ER swing tank	San Francisco, CA	119 and 135 (low-income senior housing)	2.6–2.7 (monitoring period)	25 and 27	\$4,000 and \$6,300 per residence	Valmiki 2024

Electrification of Gas Loads: Commercial and Residential

Existing Fuel Uses and Opportunities for Electrification

What Are the Opportunities To Electrify Kitchen Equipment?

Gas and electric kitchen equipment technologies available in both residential and commercial buildings.



Gas burner:

- Heats food by creating a flame controlled by mix of oxygen and natural gas applied to outside of pot, heating food via convection.
- Results in less healthy air quality than electric cooktops, heating the nearby environment, and energy loss. [Source: [Build. Decarb Guide 2023](#)]



Electric resistance coil cooktops:

- Spiral steel tubing housing a heating element is powered by electricity, heating food by conduction.
- Reduced efficiency in cooking compared to induction cooktops, as coils radiate heat downward and to sides. [Source: [Build. Decarb Guide 2023](#)]



Electric resistance ceramic cooktops:

- Coiled metal elements under tempered ceramic glass are electrically heated, heating food by convection, conduction, and radiation.
- Reduced efficiency compared to induction cooktops. [Source: [Build. Decarb Guide 2023](#)]

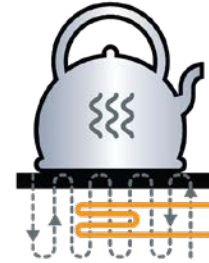

Induction cooktops:

- An alternating current passes through a coil of copper wire underneath tempered ceramic glass, creating a magnetic field. Ferrous (magnetic) cookware is placed near the field, and an electric current is induced, causing the cookware to heat.
- Energy is transferred directly from coil to the pot.
- Surrounding area is cool and safe. Cook times are faster than other methods due to efficient energy transfer.
- Ferrous (magnetic) cookware is required. [Source: [Build. Decarb Guide 2023](#)]
- Increased growth of use of induction cooktops. [Source: [Forbes 2024](#)]

What Are the Opportunities and Impacts of Electrifying Laundry Equipment?

All types of dryers available for both residential and commercial buildings

- Residential: Used in single-family residences with available space for appliances and gas/electric connections.
- Commercial: Used in multifamily laundromats, coin-operated laundromats, and on-premise laundromats (e.g., hospitals, food service, hospitality industry). [Source: [Zhang and Wei 2013](#)]



Electric dryer

- Requires a 240-V outlet and an exhaust vent.
- May result in longer drying times compared to gas dryer.
- Combined Energy Factor (CEF) range: 3.72–4.3. [Source: [Energy Star](#)]



Gas dryer

- Requires a 120-V outlet, a gas connection, and an exhaust vent.
- Needs professional installation for proper venting.
- Can cost less to operate than electric dryer.
- CEF range: 3.3–3.5. [Source: [Energy Star](#)]



Heat pump (ventless/condensing) dryers

- Models can require either 120-V or 240-V outlet.
- Dries clothes without an exhaust vent to the outside.
- Features a tumbler like a conventional dryer.
- Instead of blowing hot air over the clothes and dispersing that air outside through a duct, a heat pump dryer recycles the air.
- Heat pump condenser rejects heat to the tumbler to warm clothes and absorb moisture. Air is then passed over the evaporator, absorbing heat from the air causing moisture to condense, water then drains through a tube.
- Can be installed anywhere in a home but may require a drain.
- Dries at a lower temperature.
- CEF range: 2.7–11 depending on the voltage. [Source: [Energy Star](#)]
- Uses 28% less energy than conventional clothes dryers. [Source: [Energy Star](#)]



Combined washer and dryer

- Models can require either 120-V or 240-V outlet.
- Washes and dries clothes in the same drum with programmable controls.
- Eliminates the time clothes sit in a washer, waiting to be transferred.
- Most do not require a vent but a drain or water-collecting reservoir.
- May have increased drying time due to no venting.
- Saves space.
- Currently more expensive than conventional models.

What Are the Impacts of Electrifying Kitchens in Residential and Commercial Buildings?

Indoor air quality and health impacts

- Cooking with gas emits nitrogen oxides (NO_x), carbon monoxide (CO), formaldehyde, carbon dioxide, particulate matter, and volatile organic compounds—which can all impact human health. [Source: [Nicole 2014](#)]
 - Gas burners can add 25%–33% NO_x during summer and 35%–39% in winter. [Source: [Nicole 2014](#)]
 - Elevated levels of NO_x are associated with many health impacts including decreased lung function, exacerbating asthma, respiratory illnesses and infections, shortness of breath, wheezing, etc. [Source: [Zhu et al. 2020](#)]
 - CO is an odorless, colorless gas that in elevated indoor levels can cause brain and heart toxicity, pulmonary disease, asthma symptoms, lower respiratory infections, and death in extreme situations. [Source: [Zhu et al. 2020](#)]
 - Formaldehyde can cause respiratory, eye, and skin irritation, chest tightness, shortness of breath, and other significant effects such as cancer and death. [Source: [Zhu et al. 2020](#)]
 - Particulate matter can cause increased blood pressure, bronchitis, and asthma. [Source: [Zhu et al. 2020](#)]
- Gas cooktops and stoves can leak natural gas and other harmful pollutants even when not in use. [Source: [Nicole 2014](#)]

Induction can improve culinary performance

- Thermal comfort: Induction is more efficient than gas; it can transfer heat to the food with an 80% efficiency rate compared to 30%–35% heat transfer efficiency for gas. Open gas flames in busy commercial kitchens tend to inefficiently warm the room. [Source: [Build. Decarb Guide 2023](#)]
- Temperature responsiveness, precision, and control: Induction allows pan temperatures to react to adjustments faster than other types of equipment. [Source: [Build. Decarb Guide 2023](#)]
- Speed: Induction equipment can boil water in half the time of gas burners. [Source: [Build. Decarb Guide 2023](#)]
- Surface area: There is more working surface area available with induction equipment since the flat area can be used by other activities as long as they are not magnetic. Because the cooktop is not directly heated, burnt food is less likely and the surface is easier to clean. [Source: [Build. Decarb Guide 2023](#)]
- These improvements do require specific cookware for induction and can require user adjustment, as food will cook faster with induction. Even for cookware without a flat bottom (woks), concave induction wok hobs are available for residential use. [Source: [Build. Decarb Guide 2023](#)]

Carbon emissions of fossil fuel end uses

- Commercial kitchens consume approximately 3 times more energy per area than the average commercial building. [Source: [CBCECS 2016](#)]
- Food service takes up 2% of total commercial floor space, but accounts for 6% of primary energy consumption—one of the highest energy end uses per square foot segments of the commercial sector. [Source: [CBCECS 2016](#)]

Electric resistance cooktops

- While electric resistance cooktops are less efficient than induction, they have similar impacts to indoor air quality as induction cooktops when compared to cooking with gas. [Source: [Build. Decarb Guide 2023](#)]



Photo on left by Dennis Schroeder, NREL; Photo on right from U.S. DOE Solar Decathlon

Residential Panel Capacity

Considerations for Fully Electrifying a Residential Structure

Electrifying U.S. Households

- To eliminate 20% of national greenhouse gas emissions from residential energy use, an effective approach is to electrify U.S. dwellings while simultaneously decarbonizing the electrical supply.
[Source: [The Carbon Footprint of Household Energy Use in the United States](#)]
- A study of 1,739 home decarbonization upgrades finds that electrification, combined with photovoltaic (PV) installation and moderate weatherization upgrades, can reduce median emissions by 68%.
[Source: [The Cost of Decarbonization and Energy Upgrade Retrofits for US Homes](#)]
- U.S. homes use electricity and natural gas mainly as fuels to power systems and end uses. Space and water heating in residential buildings contribute to about 63% of residential energy consumption.
[Source: [U.S. Energy Information Administration, 2020 Residential Energy Consumption Survey](#)]
- Most U.S. households can use electricity to power all energy end uses, unlike fossil fuel-based energy sources that are primarily used for space/water heating and cooking in U.S. homes.
- Electrification of current residential end uses, adding new electrical loads from EV chargers, and generation from solar PV systems necessitates evaluation of the home's existing electricity distribution system to determine any capacity constraints.

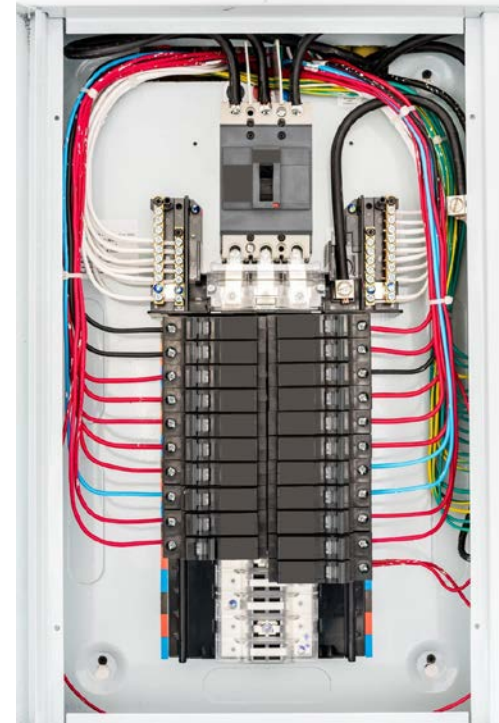
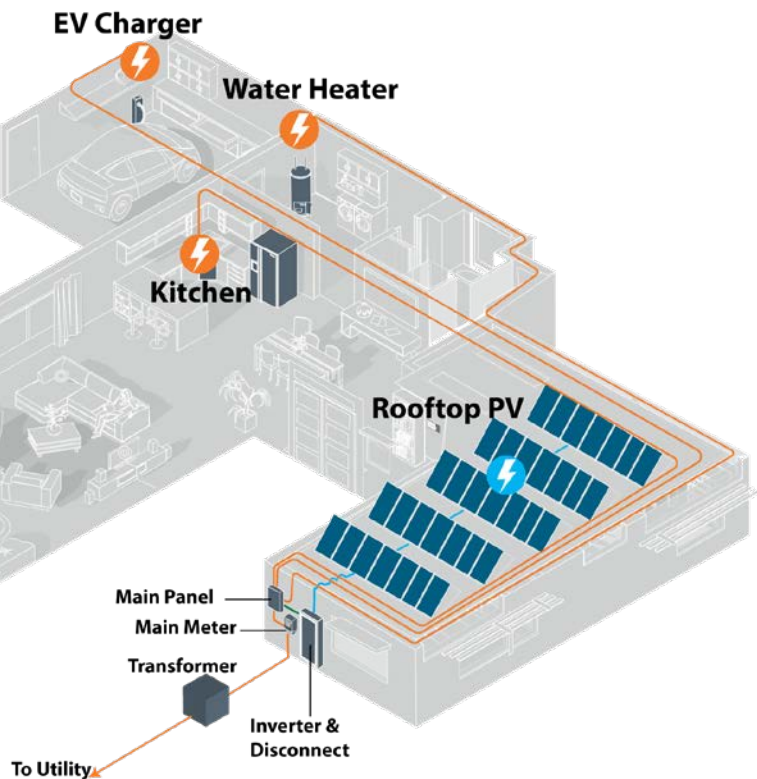

Photo of an uncovered residential electrical panel.
Photo from EKKACHAN RIMJAEM, Pond5.com

Electrifying residential end uses can reduce overall energy bills, increase safety, reduce health risks, and support the decarbonization of the energy sector.

Understanding the Residential Electrical Distribution System



Residential Electrical Panel Basics

- Electrical panels (also identified as breaker/service panels or load centers) split the incoming grid electrical service into multiple secondary circuits and include circuit protection in a common enclosure.
- Most commonly, the grid provides electrical power to the home through a 3-wire 240-V split-phase service connection. The grid service connection includes the electrical meter to track the energy used, and electrical components like wires, transformers, and protection devices.
- The residential electrical panel includes subcomponents like:
 - Protective devices for short-circuit, overcurrent, arc-fault, or ground-fault.
 - Current-carrying conductors like wires, busbars, and terminals.
 - Panel enclosure and door.

When can a residential panel or service upgrade be required?

Existing homeowners typically add or replace one electrified appliance at a time (e.g., EV charging, space/water heating, cooking, and clothes drying) instead of changing all at once. Therefore, it is common to encounter panel capacity constraints when installing an individual appliance. A panel upgrade is typically triggered in the following situations:

- Lack of physical space to add new circuits or unavailability of spare breakers to connect loads.
- The capacity or the maximum load on the electrical panel surpasses the limit as calculated by methods outlined in the National Electric Code (NEC) Article 220 or the applicable local codes enforcing organization.
- Addition of subpanels, Accessory Dwelling Units (ADUs), or connection of solar PV panels.

Consider the solutions in the following slides before planning a panel upgrade.

Solutions To Avoid Residential Panel Capacity Upgrades

- Reduce load power ratings, which can lead to a reduction in the electrical service or feeder load requirements:
 - Low-power appliances perform the same functions as less power-efficient market alternatives at a reduced nameplate rating, which reduces the overall load calculation. An example is 120-V heat pump water heaters rather than 240 V, covered previously in this report.
 - Appliances that combine multiple functions can avoid separate dedicated circuits for each equipment, such as a combined washer dryer.
- Share one receptacle on a single circuit between two large loads so that the operation is non-coincident. The load coordination is based on the user-selected priority. Typically, in normal operation, both loads energize until the total power exceeds the set power threshold, at which point the secondary circuit de-energizes until the power drops below the threshold.
- Consider solutions that address physical space constraints in the electrical panel:
 - Tandem circuit breakers with a smaller footprint can be used when spare circuits are available in the panel.
 - Subpanels can expand the circuit availability.
 - Meter collars or Dual Lug for meter socket connects prior to the main breaker can provide additional connections.

- Smart controllers can curtail or modify the load behavior to avoid overload, and include:
 - Controllable circuit breakers that de-energize the downstream circuit based on the controller signal.
 - Smart electrical panels that can intelligently monitor and modulate the circuits on the panel.
 - Home energy management systems that can help manage, optimize, and reduce peak power demand.
 - The latest NEC provides further guidance for load management in Section 750.30 for energy management systems that mitigate upgrades by managing (limiting) load on service.
- Integrated energy storage systems can shift the load away from overloading the panel. This solution is most effective for end uses that have high peak power demand over short timeframes. During inactive periods, the battery charges and later provides support during power demands.

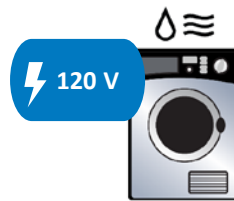

Combined and low-power appliances



Tandem skinny circuit breaker



Circuit sharing



Smart panel

Innovation Opportunities in Panel Capacity

Innovations in hardware, software, communication, and widespread information availability can support future opportunities for affordable electrification. There is great opportunity for growth and expansion in these areas:

- Devices and appliances that can pause or turn off mid-cycle and then resume seamlessly from previous state.
- Power distribution and allocation to all appliances and devices determined by available capacity on the electrical panel.
- Load control with modulation-capable appliances and equipment.
- Load control solutions that can respond to local distribution system capacity constraints that are upstream to the residential electrical panel.
- Publicly available database for “power rating” of appliances like ENERGY STAR® “energy rating” system.
- Load control communication-ready appliances and equipment.
- Integrated control platforms that address and control all levels of the system, including appliances, branch circuits, and panel boards.

Many of the currently available solutions are from smaller manufacturers or startup companies and therefore lack substantial market share or awareness among stakeholders. Some of these solutions are also in the nascent stage of implementation and are not widely available beyond pilot projects or early adopters.

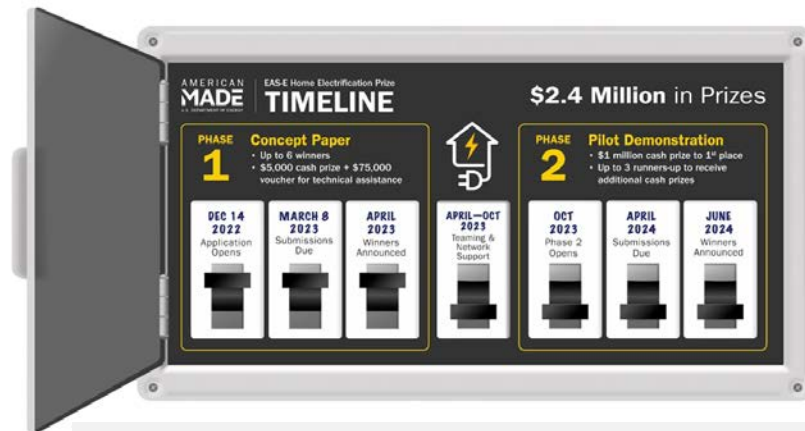

The Equitable and Affordable Solutions to Electrification (EAS-E) Home Electrification Prize provides up to \$2.4 million in prizes for innovative solutions to advance widespread electrification upgrades in residential buildings.

[Source: [EAS-E Home Electrification Prize](#)]

Electric Vehicle Impacts and Connections to Buildings

Public and Private EV Charging Flows Through a Building's Electrical Distribution System

EV Charging in Commercial and Residential Buildings

- EV car sales have experienced a consistent and significant rise in the last decade, resulting in a notable shift in market share from gasoline-powered vehicles.
- EV supply equipment (EVSE) installations have increased exponentially to provide the public charging requirements of increased EV sales.
- Energy for the majority of the public and private EVSE flows through residential and commercial building's electrical distribution system.
- Newer EVs sold in the market are capable of bidirectional power flow and offer some resilience (V2H – Vehicle to Home) in case of emergency.

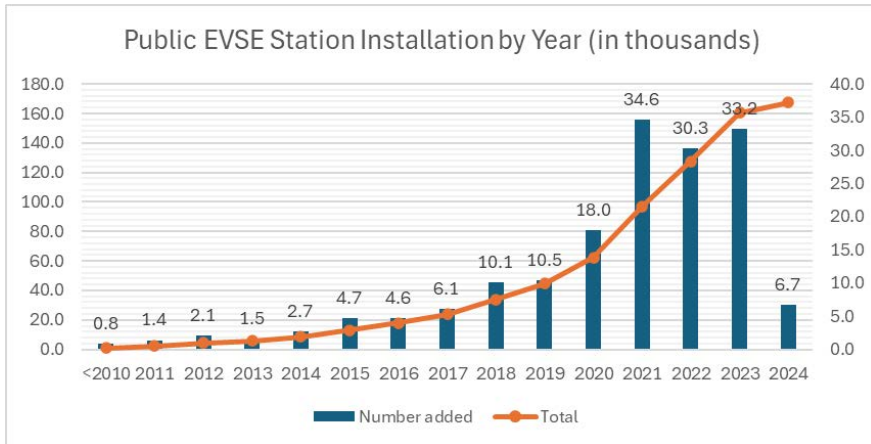

[Source: [Alternative Fueling Station Locator](#)]

Annual U.S. light-duty vehicle sales by powertrain (2014–2023)
percentage of sales

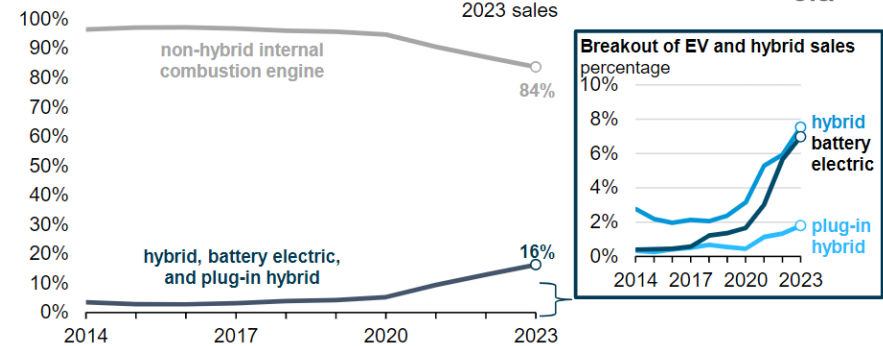

[Source: [Electric Vehicles and Hybrids Surpass 16% of Total 2023 U.S. Light-Duty Vehicle Sales](#)]

- Study by Wood et al. estimates significant ramp-up of essential public EVSE by 2030 to keep up with increased EV demand and adoption rates. [Source: [The 2030 National Charging Network: Estimating U.S. Light-Duty Demand for Electric Vehicle Charging Infrastructure](#)]
- Currently, most EV drivers, including all-electric vehicles and plug-in hybrid electric vehicles (PHEVs), charge their vehicles overnight at home. [Source: [Charging Electric Vehicles at Home](#)]
- Completely operational EVSE can become the highest electrical load in a building, surpassing heating and cooling loads. [Source: [Impact of Electric Vehicle Charging on the Power Demand of Retail Buildings](#)]
- A growing number of cities like Atlanta, Denver, and various California jurisdictions have implemented policies requiring the integration of EVSE into all new single-family home construction. [Source: [Building Electric Vehicle Ready Homes](#)]

EV chargers (EVC), EV supply equipment (EVSE), and electric vehicle charging infrastructure (EVCI) are alternative names for EV charging equipment.

EV Charging Types and Connectors

- EV charging equipment converts the alternating current (AC) power from the grid to battery-usable direct current (DC) by either the EV's onboard hardware or through external converter equipment.
- AC-to-DC conversion location, connector protocol, and the rated maximum power transfer capability during EV charging are the main classifications for commercial EVSE types.
- Charging equipment can include various subsystems like power conditioning modules, control software, safety devices, metering, communication, cooling, connectors, and wiring. [Source: [Public EV Charging Station Site Selection Checklist](#)]
- EV charging speed depends on factors like EVSE hardware design, the EV's onboard electrical system configuration, the connector rating, the battery state of charge (SoC), individual component temperatures, battery chemistry, and user-selected charging priority.
- The selection of EVSE type and quantity depends on user requirements like average daily EV mileage, battery charging patterns, expected charge time, and number and type of EVs expected to be connected in the building.
- Tesla initially developed the North American Charging Standard (NACS) connector, and this is currently under review by SAE (a global professional association and standards organization) as SAE J3400 to enable standardization across the industry. Several other automotive manufacturers plan to make their 2025 EV model year compatible with NACS. [Source: [SAE J3400 Charging Connector](#)]

Charger Technology	EVC Output Voltage/ Max Current	Max Power Levels*	Max Charge Rate*	U.S. Market Share ¹	Building Side Connector	Charger Side Connector Type	
AC	AC Level 1	120V AC / 15 A - 20 A	1.44 kW / 1.92 kW	2-6 mi/hr	<5%	BUILDING SIDE CONNECTOR AC Level 1 NEMA 5-15 NEMA 5-20 Typical 15A/20A Plug	CHARGER SIDE CONNECTOR J1772 Tesla
	AC Level 2	208V - 240V AC / 30 A-100 A	5 kW- 19.2 kW	10-60 mi/hr	80%	BUILDING SIDE CONNECTOR L14-30 NEMA 14-30 NEMA 14-50 NEMA 14-60 Typical Plug for Dryer/ Electrical Subpanel	CHARGER SIDE CONNECTOR J1772 Tesla
DC	DC Fast Chargers	50V-1000V DC / 80 A	80 kW	24-90 mi/hr	15%	BUILDING SIDE CONNECTOR AC Connected to Electrical Subpanel	CHARGER SIDE CONNECTOR J1772 CCS CHAdeMO Tesla
	DC Extreme Fast Chargers (XFC)	50V-1000V DC / 400 A	400 kW	80% of capacity in 30-40 mins			
	Tesla Super-charger	50 - 410 V DC / 330 A	140 kW	Up to 170 miles in 30 mins			

Illustration by Marjorie Schott, NREL, with components from Pond5.com. [Source: [Connecting Electric Vehicle Charging Infrastructure to Commercial Buildings](#)]

EVSE Availability in the United States

- Installation of ENERGY STAR-certified EVSE can use 40% less energy than a standard EVSE in standby modes. [Source: [Charge Your Electric Vehicle Sustainably With Green Power](#)]
- **Level 1 chargers** – Slowest charging rate; EV drivers mainly use it in homes or emergency charging situations, while Level 2 is currently the most implemented type.
- **Level 1 and 2 chargers** – Most suitable for buildings with long average parking durations, like residential and office buildings.
- **Level 2 and DC fast chargers** – Ideal in commercial buildings where average parking durations are short, such as grocery or retail stores, restaurants, and medical office buildings. Also, suitable for overnight charging for commercial EVs, like short-haul delivery trucks and buses at fleet facilities and parking garages.
- **High-power DC fast chargers** – Suitable for long-distance interstate EV travel and fleet vehicles with high battery storage capacity like electric long-haul trucks and buses charged at the commercial buildings along highway corridors or truck depots.

Share of Public EVSE Ports by Charging Level

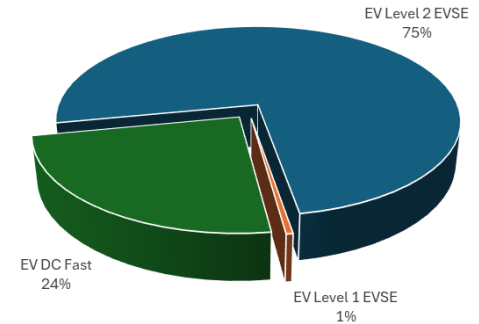

[Source: [Alternative Fueling Station Locator](#)]

Public DC Charger Power Level (kW) Availability

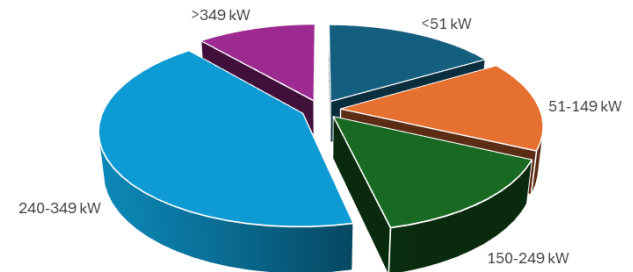

[Source: [Electric Vehicle Charging Infrastructure Trends from the Alternative Fueling Station Locator: Third Quarter 2023](#)]

Statewise Number of Public EVSE and Charging Level Type

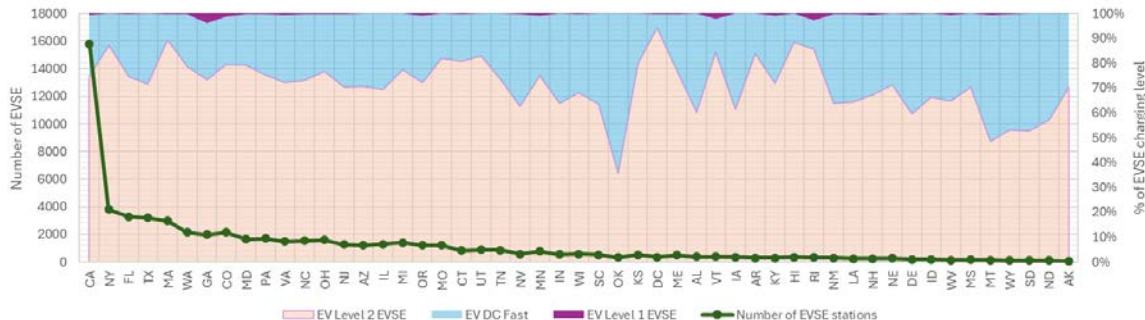

[Source: [Alternative Fueling Station Locator](#)]

Adding EVSE to Buildings – Considerations

- It is recommended to thoroughly review the building's existing electrical hardware, power, and energy consumption before installing any EVSE.
- Electrical requirements for EVSE:
 - Dedicated capacity on the subpanel where EVSE hardware is added.
 - Correct sizing of components like wiring, panels, and circuit breakers.
 - Sufficient electrical capacity for the utility service to the building's main electrical distribution panel.
- If sufficient capacity is not available, changes to the building electrical distribution must be determined, including:
 - New electrical panels, wiring, safety devices, and connections to EVSE.
 - Additional panel(s) and communication infrastructure for networked EVSE.
 - New transformer on-site and/or for the utility. Upgrading electrical service from the utility connection to the customer.
- The price of EVSE hardware will depend on its charging capacity, networking features, and mounting type. The charging equipment cost per port can range from \$380 to \$3,500 for AC chargers and \$38,000–\$90,000 for DC chargers. [Source: [Procurement and Installation for Electric Vehicle Charging Infrastructure](#)]
- Apart from the EVSE hardware costs, other additional costs include:
 - Permitting, inspection, engineering design review, and drawings.
 - Installation costs to connect charging equipment to electrical service.
 - Electrical infrastructure upgrade equipment if limited capacity is available.
 - Civil infrastructure upgrades for EVSE equipment and the electrical infrastructure.
 - EVSE auxiliary systems like payment systems and connectivity equipment (for commercial buildings or public charging stations).
 - Operational electrical utility costs (electricity consumption rate, time-of-use charges, demand charges).

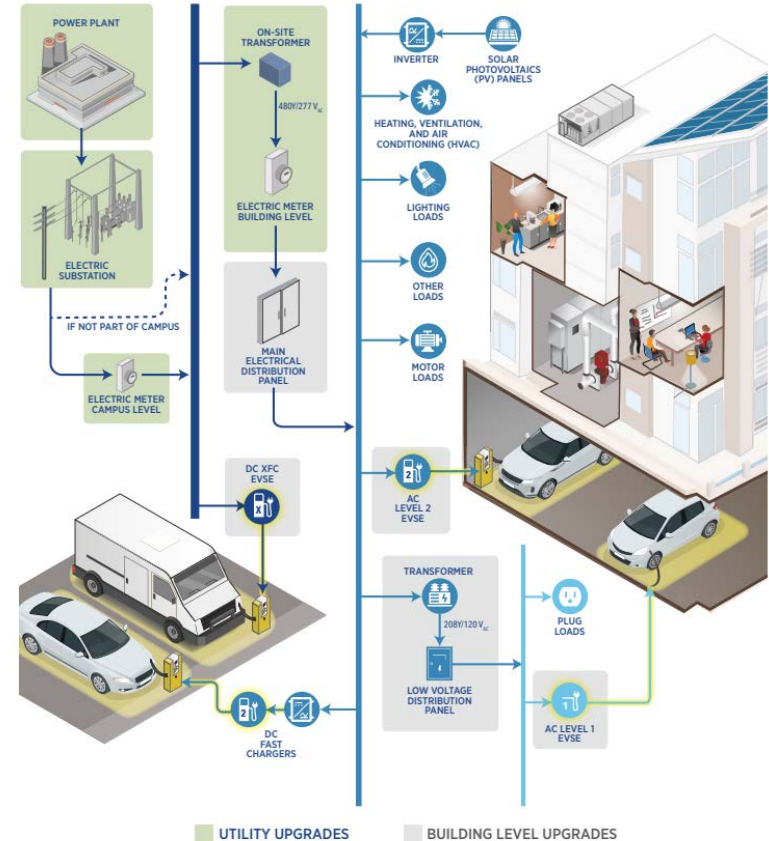

Illustration by Marjorie Schott, NREL, with components from Pond5.com and iStockphoto.com. [Source: [Connecting Electric Vehicle Charging Infrastructure to Commercial Buildings](#)]

Building Envelope Improvements and Thermal Energy Storage (TES) Opportunities

Synergies Between Envelope Improvements and TES

Interactions: Envelope Improvements, Controls, and TES

- About **half of the U.S. building stock** was built before building codes became common in 1980. Many buildings haven't been upgraded, including the envelope, since they were built. [Source: [National Blueprint for the Buildings Sector](#)]
- Envelope improvements are **key enabling technologies** for successful electrification.
- Envelope improvements **can save thousands of dollars on the upfront cost** of heat pump installation: with a tighter envelope, the installed heat pump could be smaller and less expensive. [Source: [Wilson et al. 2023](#)]
- **Co-benefits such as comfort and thermal resilience** can also result from envelope improvement, improving occupant experiences. [Source: [Wilson et al. 2023](#)]
- Envelope improvements can also contribute to **reducing the size of a building's TES**: a tighter envelope means less heating and cooling loss and less energy needed to condition the building, so energy storage can be smaller and still serve the building's systems well.

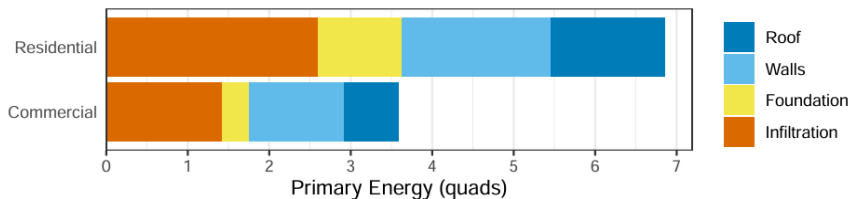

The breakdown of energy use by building envelope component in residential and commercial buildings during the heating and cooling seasons shows that the opaque envelope is the largest contributor to envelope-related energy use, followed by air leakage (infiltration and exfiltration).

Data from Langevin et al. [2] and the EIA 2021 Annual Energy Outlook [1].

[Source: [Harris, 2021](#)]

Residential Building
Year Built

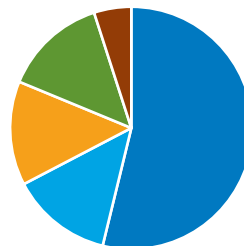

■ Pre 1980 ■ 1980s ■ 1990s ■ 2000s ■ After 2010

Commercial Building
Year Built

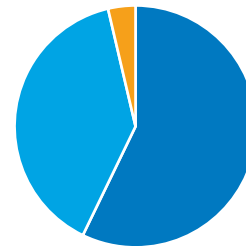

■ Pre 1980 ■ 1980-2004 ■ After 2004

[Sources: [ResStock](#); [ComStock](#)]

Smart controls are also key technologies for electrification and integration with TES: while envelope improvements can decrease the energy needs of a building, **controls can facilitate optimal performance of building equipment**. For example, when and how a building draws on TES.

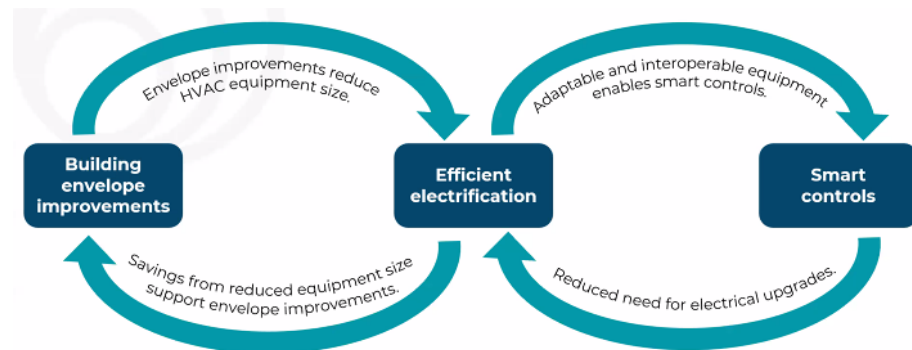

[Source: [Affordable Home Energy Earth Shot Inaugural Summit](#)]

Building Energy Storage and Peak Electrical Demand

Energy storage makes buildings more resilient and significantly contributes to managing and shifting buildings' peak electrical demand.

Peak energy demand in buildings will rise due to heating electrification

- Widespread electrification goals of building end uses can lead to 2.5x increase in annual heating electricity, along with higher coincident electrical peak demand, particularly for regions in colder climates. [Source: [NREL Electrification Futures Study, 2018](#)]
- All-electric heating (high-COP HP) scenario without storage can increase peak demand by 70% throughout the U.S., with 23 states more than doubling their peak. [Source: [Waite 2020](#)]
- New York Independent System Operator (NYISO) forecasts winter peak will be twice the current peak while summer peak will remain constant over the next 30 years. [Source: [NYISO](#)]
- Extreme weather events further exacerbate building thermal load requirements and may not be considered in forecasts and studies.
- Energy storage can help mitigate the increase in peak electricity demand from electrification.
- Envelope improvements can help reduce loads and required TES sizes.

Energy storage required to support commercial and residential buildings in the United States for a 2050 grid with 100% renewable energy, disaggregated into thermal and nonthermal storage, assuming electrified heating with ASHPs.

Strategic investments to reduce TES and electrical energy storage (EES) costs can be traded off with investments in electrical distribution system, TOU rates, and service upgrades.

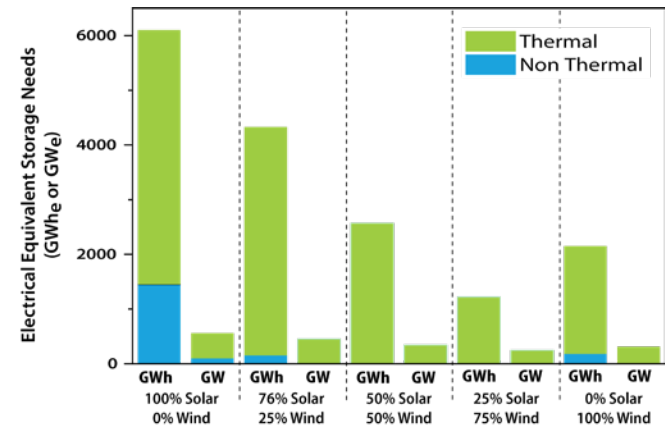
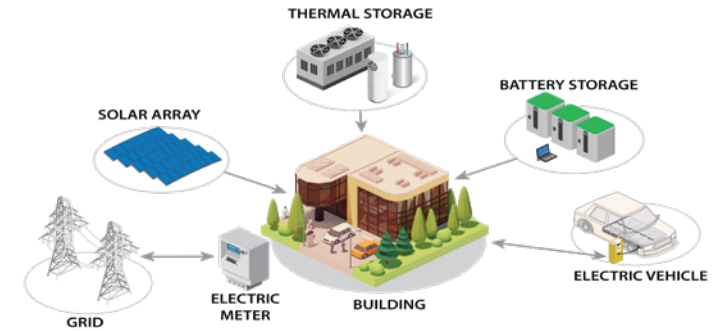

[Source: [Odukamaiya et al. 2021](#)]



Thermal Energy Storage in Buildings: What and Why?

TES and EES, or batteries, are the main storage types used in buildings.

TES systems provide heat storage capability for heating or cooling loads. TES can lower heating and cooling equipment costs while increasing thermal system effective capacity.

EES can handle a wide range of end loads to provide backup electrical power, as long as it is electric. Useful for buildings that frequently experience power disruptions or need backup for critical loads.

What is TES?

- TES systems or “thermal batteries” provide heat storage capabilities that can be used for both heating or cooling requirements in a building.
- Integration in buildings is achieved through pairing TES with space conditioning equipment or embedded within envelope materials.
- Active TES typically consists of storage media, a heat exchange device, and supervisory control.
- Heat storage mechanisms in buildings (for examples see following slide): [Source: [Borri et al. 2021](#)]
 - Sensible: Energy required for temperature change. 
 - Latent: Energy required for phase change. 
 - Thermo-chemical: Energy stored in reversible chemical reaction.
- Currently, systems like a hot water heaters or existing thermal mass of the building can store heat but lacks supervisory control for coordinated charging/discharging.

Why TES?

- Provides the ability to align facility energy use with the clean electricity supplied by grid or on-site photovoltaic system to reduce indirect CO₂ emissions. Flatten the duck curve by storing excess renewable energy in the grid that would otherwise be curtailed.
- Reduce energy cost by cutting peak demand and taking advantage of time-of-use (TOU) rates.
- Opportunities to improve overall system efficiency. For example, for cooling loads, storage can charge at night when chillers operate more efficiently due to lower ambient temperatures.
- Support grid services like operating in daytime when there is PV, demand response, critical price period response, and load flexibility during emergency.
- Potential to improve resilience by maintaining end-use service delivery and extending the duration of acceptable indoor conditions during brief grid outages and interruptions.
- Foster equitable and sustainable electrification by avoiding/lowering upgrade costs for electrical distribution system components like panels, service, and transformers by reducing system peaks and equipment ratings.

Load Shaving/Load Leveling

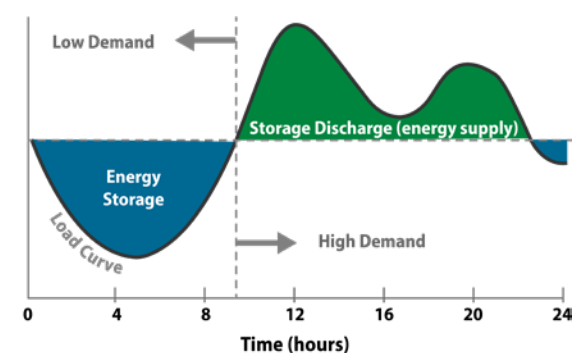

[Source: [Argyrou et al. 2018](#)]

Thermal Energy Storage in Buildings: Current State of the Art

Commercially available TES system types

- Equipment-integrated TES with sensible storage
 - Commercial and residential electric resistance or heat pump water heaters with tanks
 - District or campus-scale chilled and hot water storage tanks
 - Bricks that are integrated with HVAC systems.
- Equipment-integrated TES with latent storage
 - Ice storage tanks connected to central chiller plant
 - Ice storage integrated in RTU
 - Refrigeration system with thermal storage system.
- Envelope-integrated TES
 - Phase change material integrated to components like ceiling panels or walls for passive storage
 - Additional thermal mass that can be incorporated in the building envelope. Example: ceramic brick heating storage system
 - Sophisticated control within buildings energy management system that utilizes thermal mass for precooling/preheating and coasting through peak period.

Practical considerations for TES installation

- Space requirement for adding stand-alone TES system to existing building.
- Integrating a TES into a building may require changes to multiple components like chillers, plumbing, and control in existing space conditioning systems.
- Sophisticated controls are essential to maximize the benefits from utility rate structures, demand or carbon reduction, and interfacing with other building systems.
- TES-integrated devices are designed at the point of manufacturing to be seamlessly coupled with other building services along with flexibility of plug-and-play compatibility.
- Although some TES can allow for both heating and cooling, TES optimized for space cooling is generally more effective in very warm climates, while space heating TES is more effective in cold climates.



Photo by Julianne Boden [Link](#)



Photo by Dennis Schroeder NREL 62053



Photo by Dennis Schroeder NREL 62043

Thermal Energy Storage: Opportunities

Utility Programs and Federal Support for TES

- Utility demand response/demand flexibility program incentives, in addition to demand charges and TOU pricing, can generate more favorable savings for TES.
- Federal programs like the Inflation Reduction Act can provide an investment tax credit* for installation of most TES systems of up to 40%. [Source: [IRS Form 3468](#)]

New technologies under development

- Equipment-integrated TES solutions, designs, and sizing tools
- Next-generation storage materials with low-cost, suitable transition temperature and high energy density
- Desiccant-based TES and storage for dehumidification
- Dynamically tunable thermal storage materials
- Customer- and building-owner-focused software tools to quantify the overall benefits and economics of storage.

The DOE's [Energy Storage Grand Challenge](#) is a comprehensive program to accelerate the development, commercialization, and utilization of next-generation energy storage technologies and sustain American global leadership in energy storage.

*Disclaimer: Consult your tax advisor for specific details on your project.



Learn more on
<https://www.energy.gov/eere/buildings/stor4build>



Accelerating the Equitable Growth, Optimization, and Deployment of Cost-Effective Storage Technologies for Buildings

- Stor4Build is addressing the need for equitable solutions that ensure that benefits of storage technologies are clear for all communities.
- 5-year goal is to implement a community-scale demonstration of technologies, which will serve as a foundation for large-scale deployments of thermal and battery energy storage and systems capable of satisfying both heating and cooling needs in buildings.
- Multilab consortium includes active participants from industry, utilities, nonprofit organizations, communities, building owners, academia, government, and other research institutions.
- Two steering councils (R&D and Market Adoption) support equity-centric scaled adoption of building energy storage technologies and a market transformation to increase market viability.

Funded By



Supported By



Co-Directors



Terminology and Acronyms

- **AC:** alternating current
- **ALU:** advanced load up
- **ASHP:** air-source heat pump
- **BLU:** basic load up
- **CCHP:** cold climate heat pump
- **CEF:** Combined Energy Factor
- **CO:** carbon monoxide
- **CO₂:** carbon dioxide
- **CO₂e:** carbon dioxide equivalents
- **COP:** coefficient of performance
- **DC:** direct current
- **DHW:** domestic hot water
- **DOE:** U.S. Department of Energy
- **EES:** electrical energy storage
- **ER:** electric resistance
- **EV:** electric vehicle
- **EVC:** EV chargers
- **EVCI:** EV charging infrastructure
- **EVSE:** EV supply equipment
- **FHR:** first hour rating
- **GHG:** greenhouse gas
- **GHP:** geothermal heat pump
- **GWP:** global warming potential
- **HPWH:** heat pump water heater
- **HVAC:** heating, ventilating, and air conditioning
- **IEA:** International Energy Agency
- **kW:** kilowatt
- **LCA:** life cycle assessment
- **NACS:** North America Charging Standard
- **NEC:** National Electric Code
- **NEEA:** Northwest Energy Efficiency Alliance
- **NO_x:** nitrogen oxides
- **PV:** photovoltaic
- **RTU:** rooftop unit
- **SoC:** state of charge
- **TES:** thermal energy storage
- **TOU:** time of use
- **UEF:** uniform energy factor

Thank You

www.nrel.gov

NREL/TP-5500-88309

This work was authored by the National Renewable Energy Laboratory, operated by Alliance for Sustainable Energy, LLC, for the U.S. Department of Energy (DOE) under Contract No. DE-AC36-08GO28308. Funding provided by U.S. Department of Energy Office of Energy Efficiency and Renewable Energy Building Technologies Office. The views expressed in the article do not necessarily represent the views of the DOE or the U.S. Government. The U.S. Government retains and the publisher, by accepting the article for publication, acknowledges that the U.S. Government retains a nonexclusive, paid-up, irrevocable, worldwide license to publish or reproduce the published form of this work, or allow others to do so, for U.S. Government purposes.

Authorship [CRediT](#): Kelsea Dombrovski: Conceptualization (equal), Data Curation (equal), Formal analysis (equal), Funding acquisition (equal), Investigation (equal), Methodology (equal), Supervision (equal), Writing – Original Draft Preparation (equal), Writing – Review and editing (equal); Heather Goetsch: Data curation (equal), Formal analysis (equal), Investigation (equal), Writing – Original draft preparation; Omkar Ghatpande: Data curation (equal), Formal analysis (equal), Investigation (equal), Writing – Original draft preparation; Jeff Maguire: Data curation (equal), Formal analysis (equal), Investigation (equal), Writing – Original draft preparation; Kim Trenbath: Conceptualization (equal), Funding acquisition (equal), Methodology (equal), Supervision (equal); Writing – Review and editing (equal)

Acknowledgements: Chris Bowyer, Deanna Cook, Michael Deru, Tim LaClair, Jeff Munk, Marj Schott, Margaux Seward, Bethany Sparn

